



Technical Specification

Features

- Wire Wound Construction
- Magnetic Shielded Construction
- Excellent environmental characteristics
- Excellent Mechanical Strength
- Excelent Solderability
- High reliability
- Low DCR Large Curent

Applications

- LCD Television
- Automotive Systems
- Computer / Peripheral Equipment
- GPS, DC/Dc Converter, XDSL Modem
- Electronic Games
- Communications Equipment
- General Electronic Applications
- Network Systems

Technical Dimensions

A (mm)	B (mm)	C (mm)	D (mm)
11,0	14,0	5,0	5,0 +/-0,5
E (mm)			
0,70			

Dimensions

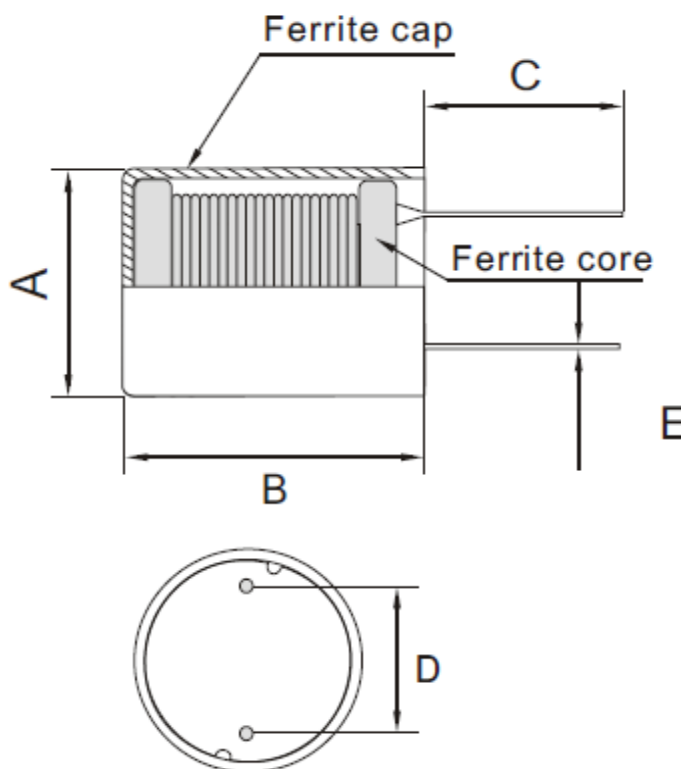

Electrical Characteristics

Technical Information

Testing LCR Bridge, measured @ 1KHz 0,1V HP4284A
 Equivalent acceptacle
 RDC. QuadTech 1880 Milliohmmeter
 IDC: Max. Lowers inductance by 10%
 Operating Temperature: -40°C ~ +105°C
 Storage Temperature: -40°C ~ +105°C
 Solder Methods: Vapor Phase, Infrared Reflow
 Marking: Inductance and tolerance
 Note: All specifications subject to change without notice.

Inductance	Inductance Code	IDC	DCR max.
5600µH	562	0,140A	3,800Ω

THT Radial Shielded Power Choke

Part No.: **S10R34**
 Customer:

DRW:	Jason	CHKD	Jules	MATL:	Wu	DATE	02.05.2009
APPD:	Join			FINISH	Shieh	Sheet	1 from 2



Soldering Profile

Classification Reflow Profile (JEDEC J-STD-020C)

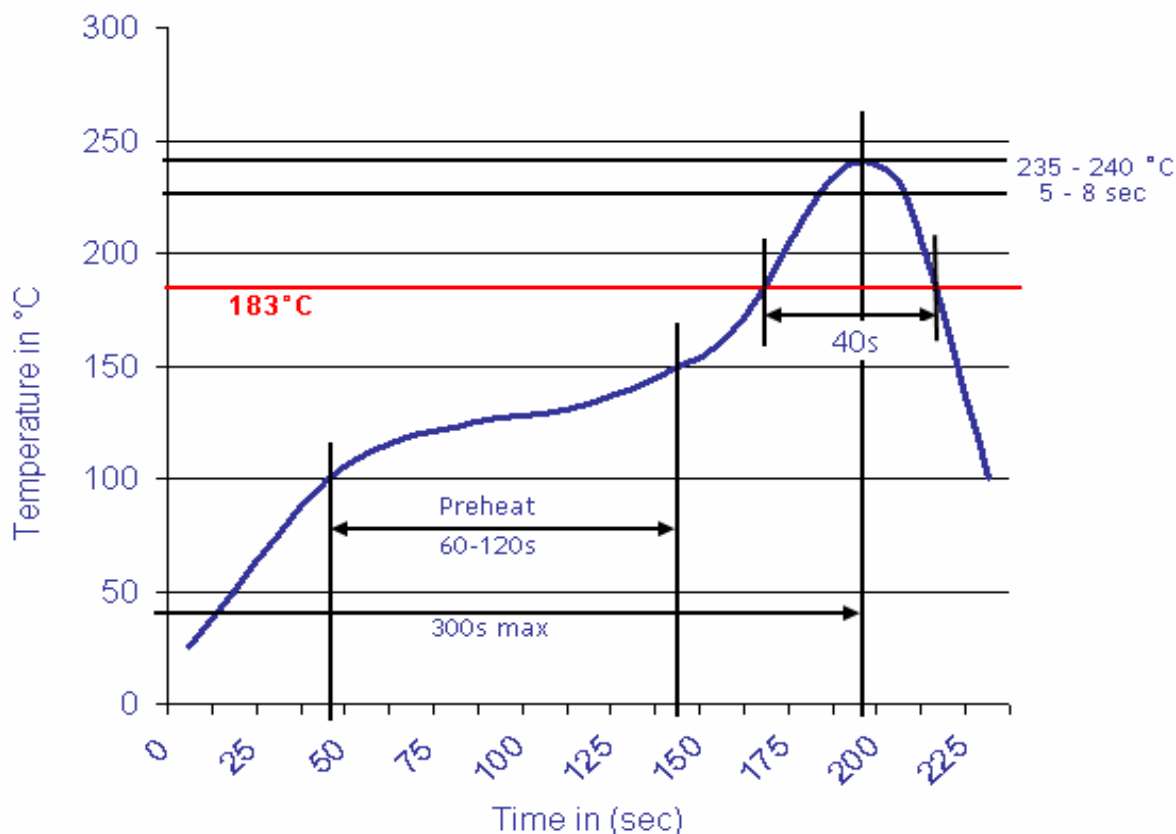

Ordering Information

Serie	Inductance	Tolerance	Lead Length	ROHS	Packing
S10R34	562	K	50	R	BU10

562= 5600µH	K= Tol. 10%	50= 5mm	R= ROHS conform	BU= Bulk Ware
	J= Tol. 5%		N= NON ROHS conform	TY= Tray Package

THT Radial Shielded Power Choke	
Part No.:	S10R34
Customer:	

DRW:	Jason	CHKD	Jules	MATL:	Wu	DATE	02.05.2009
APPD:	Join			FINISH	Shieh	Sheet	2 from 2

