



## Technical Specification

### Features

- Wire Wound Construction
- Magnetic Shielded Construction
- Excellent environmental characteristics
- Excellent Mechanical Strength
- Excelent Solderability
- High reliability
- Low DCR Large Curent

### Applications

- LCD Television
- Automotive Systems
- Computer / Peripheral Equipment
- GPS, DC/Dc Converter, XDSL Modem
- Electronic Games
- Communications Equipment
- General Electronic Applications
- Network Systems

### Technical Dimensions

A (mm)	B (mm)	C (mm)	D (mm)
11,0	14,0	5,0	5,0 +/-0,5
E (mm)			
0,70			

### Dimensions

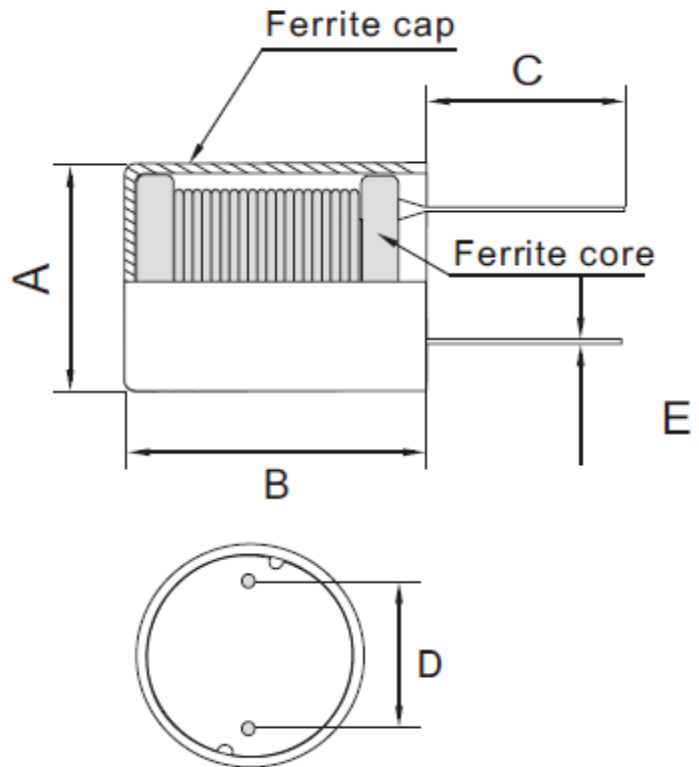

## Electrical Characteristics

### Technical Information

- Testing LCR Bridge, measured @ 1KHz 0,1V HP4284A
- Equivalent acceptacle
- RDC. QuadTech 1880 Milliohmmeter
- IDC: Max. Lowers inductance by 10%
- Operating Temperature: -40°C ~ +105°C
- Storage Temperature: -40°C ~ +105°C
- Solder Methods: Vapor Phase, Infrared Reflow
- Marking: Inductance and tolerance
- Note: All specifications subject to change without notice.

Inductance	Inductance Code	IDC	DCR max.
47000µH	473	0,060A	30,400Ω

### THT Radial Shielded Power Choke

Part No.: **S10R34**

Customer:

DRW:	Jason	CHKD	Jules	MATL:	Wu	DATE	02.05.2009
APPD:	Join			FINISH	Shieh	Sheet	1 from 2

Copyright by EDCON-COMPONENTS H.Schmitt 20.6.2008



**Soldering Profile**

**Classification Reflow Profile (JEDEC J-STD-020C)**



**Ordering Information**

Serie	Inductance	Tolerance	Lead Length	ROHS	Packing
<b>S10R34</b>	<b>473</b>	<b>K</b>	<b>50</b>	<b>R</b>	<b>BU10</b>

<b>473=</b> 47000µH	<b>K= Tol. 10%</b>	<b>50= 5mm</b>	<b>R= ROHS conform</b>	<b>BU= Bulk Ware</b>
	<b>J= Tol. 5%</b>		<b>N=NON ROHS conform</b>	<b>TY= Tray Package</b>

<b>THT Radial Shielded Power Choke</b>	
Part No.:	<b>S10R34</b>
Customer:	

DRW:	Jason	CHKD	Jules	MATL:	Wu	DATE	02.05.2009
APPD:	Join			FINISH	Shieh	Sheet	2 from 2

