



### Technical Specification

#### Features

- Wire Wound Construction
- Magnetic Shielded Construction
- Excellent environmental characteristics
- Excellent Mechanical Strength
- Excelent Solderability
- High reliability
- Low DCR Large Curent

#### Applications

- LCD Television
- Automotive Systems
- Computer / Peripheral Equipment
- GPS, DC/Dc Converter, XDSL Modem
- Electronic Games
- Communications Equipment
- General Electronic Applications
- Network Systems

#### Technical Dimensions

A (mm)	B (mm)	C (mm)	D (mm)
11,0	14,0	5,0	5,0 +/-0,5
E (mm)			
0,70			

#### Dimensions

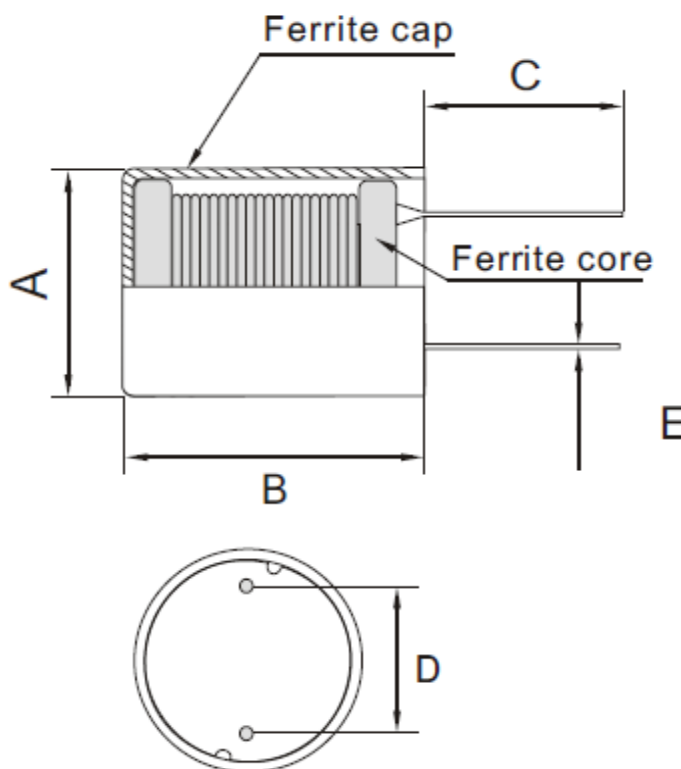

### Electrical Characteristics

#### Technical Information

Testing LCR Bridge, measured @ 1KHz 0,1V HP4284A  
 Equivalent acceptacle  
 RDC. QuadTech 1880 Milliohmmeter  
 IDC: Max. Lowers inductance by 10%  
 Operating Temperature: -40°C ~ +105°C  
 Storage Temperature: -40°C ~ +105°C  
 Solder Methods: Vapor Phase, Infrared Reflow  
 Marking: Inductance and tolerance  
 Note: All specifications subject to change without notice.

Inductance	Inductance Code	IDC	DCR max.
3300µH	332	0,200A	2,300Ω

#### THT Radial Shielded Power Choke

Part No.: **S10R34**  
 Customer:

DRW:	Jason	CHKD	Jules	MATL:	Wu	DATE	02.05.2009
APPD:	Join			FINISH	Shieh	Sheet	1 from 2



**Soldering Profile**

**Classification Reflow Profile (JEDEC J-STD-020C)**



**Ordering Information**

Serie	Inductance	Tolerance	Lead Length	ROHS	Packing
<b>S10R34</b>	<b>332</b>	<b>K</b>	<b>50</b>	<b>R</b>	<b>BU10</b>

<b>332=</b> 3300µH	<b>K=</b> Tol. 10%	<b>50=</b> 5mm	<b>R=</b> ROHS conform	<b>BU=</b> Bulk Ware
	<b>J=</b> Tol. 5%		<b>N=</b> NON ROHS conform	<b>TY=</b> Tray Package

<b>THT Radial Shielded Power Choke</b>	
Part No.:	<b>S10R34</b>
Customer:	

DRW:	Jason	CHKD	Jules	MATL:	Wu	DATE	02.05.2009
APPD:	Join			FINISH	Shieh	Sheet	2 from 2

