



### Technical Specification

#### Features

- Wire Wound Construction
- Excellent heat resistance
- Excellent environmental characteristics
- High reliability

#### Applications

- Power Supplies
- SCR and TRIAC Controls
- RFI Suppression
- Filters
- Switching Regulators

#### Technical Dimensions

A (mm)	B (mm)	C (mm)	D (mm)
8,5	3,5 +/-1,0	5,0 +/-0,3	10,5
E (mm)			
0,7			

#### Dimensions

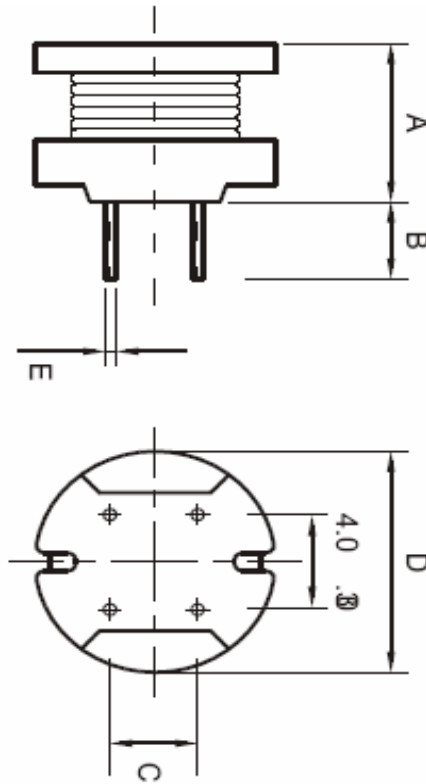

### Electrical Characteristics

#### Technical Information

Testing LCR Bridge, measured @ 1KHz 0,1V HP4284A  
 Equivalent acceptacle  
 RDC. QuadTech 1880 Milliohmmeter  
 IDC: Max. Lowers inductance by 10%  
 Operating Temperature: -55°C ~ +125°C  
 Storage Temperature: -55°C ~ +125°C  
 Solder Methods: Vapor Phase, Infrared Reflow  
 Shrink tube: Flame retardent UL type VW-1  
 Marking: Inductance and tolerance  
 Note: All specifications subject to change without notice.

Inductance	Inductance Code	IDC	DCR max.
330µH	331	0,790A	0,690Ω

#### THT Radial Power Choke

Part No.: **S10R20**

Customer:

DRW:	Jason	CHKD	Jules	MATL:	Wu	DATE	26.04.2009
APPD:	Join			FINISH	Shieh	Sheet	1 from 2

Copyright by EDCON-COMPONENTS H.Schmitt 20.6.2008



**Soldering Profile**

**Classification Reflow Profile (JEDEC J-STD-020C)**



**Ordering Information**

Serie	Inductance	Tolerance	Lead Length	ROHS	Packing
-------	------------	-----------	-------------	------	---------

<b>S10R20</b>	<b>331</b>	<b>M</b>	<b>50</b>	<b>R</b>	<b>BU10</b>
---------------	------------	----------	-----------	----------	-------------

<b>331= 330µH</b>	<b>M= Tol. 20%</b>	<b>50= 5mm</b>	<b>R= ROHS conform</b>	<b>BU= Bulk Ware</b>
	<b>K= Tol. 10%</b>	<b>15= 15mm</b>	<b>N=NON ROHS conform</b>	<b>TY= Tray Package</b>

<b>THT Radial Power Choke</b>	
Part No.:	<b>S10R20</b>
Customer:	

DRW:	Jason	CHKD	Jules	MATL:	Wu	DATE	26.04.2009
APPD:	Join			FINISH	Shieh	Sheet	2 from 2

