



Technical Specification

Features

- Wire Wound Construction
- Excellent heat resistance
- Excellent environmental characteristics
- High reliability

Applications

- Power Supplies
- SCR and TRIAC Controls
- RFI Suppression
- Filters
- Switching Regulators

Dimensions

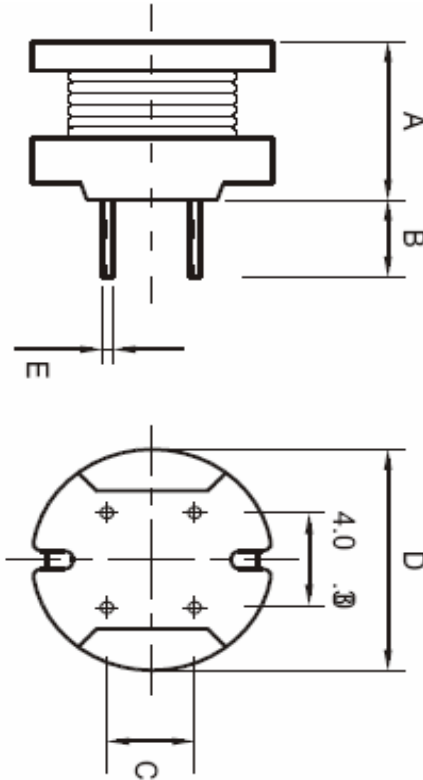

Technical Dimensions

A (mm)	B (mm)	C (mm)	D (mm)
8,5	3,5 +/-1,0	5,0 +/-0,3	10,5
E (mm)			
0,7			

Electrical Characteristics

Technical Information

Testing LCR Bridge, measured @ 1KHz 0,1V HP4284A
 Equivalent acceptacle
 RDC. QuadTech 1880 Milliohmmer
 IDC: Max. Lowers inductance by 10%
 Operating Temperature: -55°C ~ +125°C
 Storage Temperature: -55°C ~ +125°C
 Solder Methods: Vapor Phase, Infrared Reflow
 Shrink tube: Flame retardent UL type VW-1
 Marking: Inductance and tolerance
 Note: All specifications subject to change without notice.

Inductance	Inductance Code	IDC	DCR max.
12μH	120	4,100A	0,031Ω

THT Radial Power Choke

Part No.: **S10R20**

Customer:

DRW:	Jason	CHKD	Jules	MATL:	Wu	DATE	26.04.2009
APPD:	Join			FINISH	Shieh	Sheet	1 from 2

Copyright by EDCON-COMPONENTS H.Schmitt 20.6.2008



Soldering Profile

Classification Reflow Profile (JEDEC J-STD-020C)



Ordering Information

Serie	Inductance	Tolerance	Lead Length	ROHS	Packing
-------	------------	-----------	-------------	------	---------

S10R20	120	M	50	R	BU10
---------------	------------	----------	-----------	----------	-------------

120= 12µH	M= Tol. 20%	50= 5mm	R= ROHS conform	BU= Bulk Ware
	K= Tol. 10%	15= 15mm	N= NON ROHS conform	TY= Tray Package

THT Radial Power Choke	
Part No.:	S10R20
Customer:	

DRW:	Jason	CHKD	Jules	MATL:	Wu	DATE	26.04.2009
APPD:	Join			FINISH	Shieh	Sheet	2 from 2

