



## Technical Specification

### Features

Wire Wound Construction  
 Excellent heat resistance  
 Excellent environmental characteristics  
 High reliability

### Applications

Power Supplies  
 SCR and TRIAC Controls  
 RFI Suppression  
 Filters  
 Switching Regulators

### Dimensions

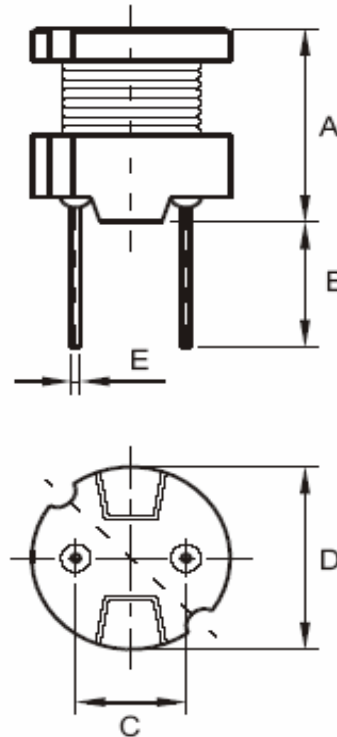

### Technical Dimensions

A (mm)	B (mm)	C (mm)	D (mm)
9,5	5,0 +/-1,0	5,0 +/-0,3	8,3
E (mm)			
0,7			

## Electrical Characteristics

### Technical Information

Testing LCR Bridge, measured @ 1KHz 0,1V HP4284A  
 Equivalent acceptacle  
 RDC. QuadTech 1880 Milliohmmer  
 IDC: Max. Lowers inductance by 10%  
 Operating Temperature: -40°C ~ +105°C  
 Storage Temperature: -40°C ~ +105°C  
 Solder Methods: Vapor Phase, Infrared Reflow  
 Shrink tube: Flame retardent UL type VW-1  
 Marking: Inductance and tolerance  
 Note: All specifications subject to change without notice.

Inductance	Inductance Code	IDC	DCR max.
470µH	471	0,430A	0,890Ω

### THT Radial Power Choke

Part No.: **S10R17**

Customer:

DRW:	Jason	CHKD	Jules	MATL:	Wu	DATE	18.04.2009
APPD:	Join			FINISH	Shieh	Sheet	1 from 2

Copyright by EDCON-COMPONENTS H.Schmitt 20.6.2008



**Soldering Profile**

**Classification Reflow Profile (JEDEC J-STD-020C)**

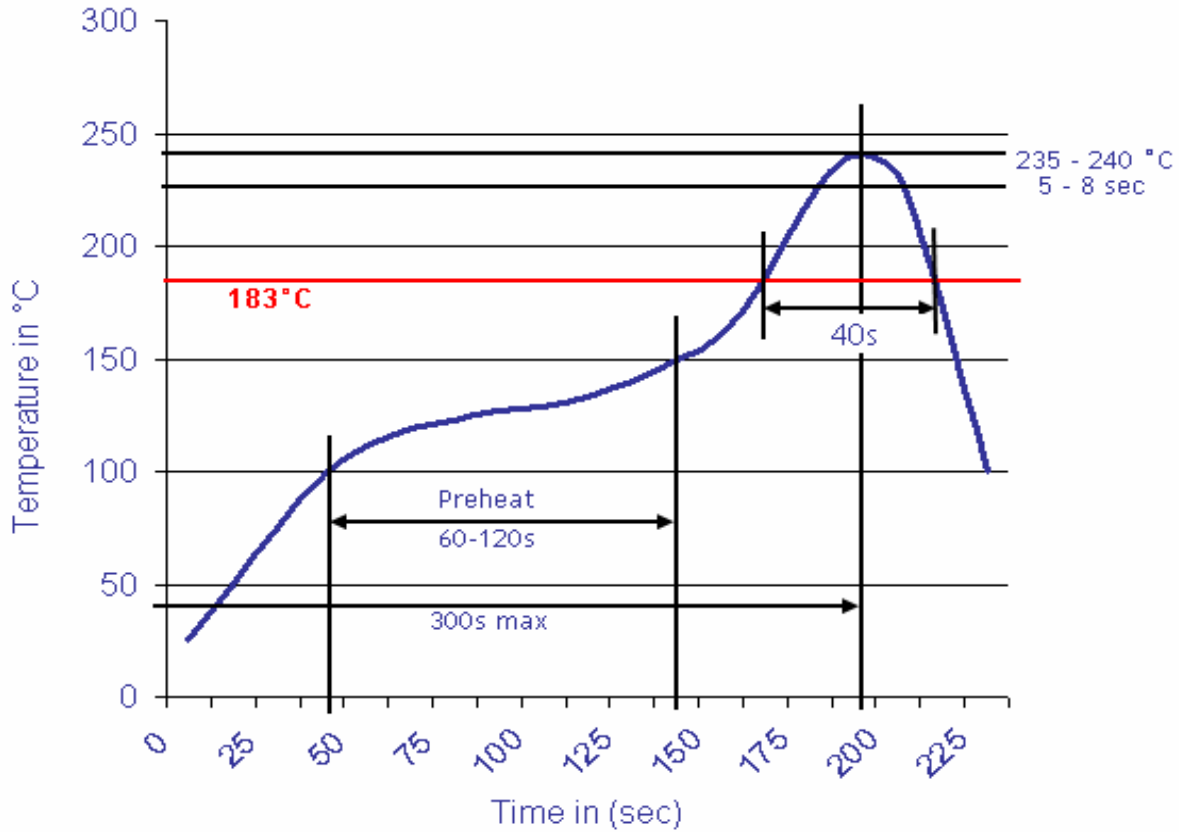

**Ordering Information**

Serie	Inductance	Tolerance	Lead Length	ROHS	Packing
<b>S10R17</b>	<b>471</b>	<b>M</b>	<b>50</b>	<b>R</b>	<b>BU10</b>

471= 470µH	M= Tol. 20%	50= 5mm	R= ROHS conform	BU= Bulk Ware
	K= Tol. 10%	15= 15mm	N=NON ROHS conform	TY= Tray Package

<b>THT Radial Power Choke</b>	
Part No.:	<b>S10R17</b>
Customer:	

DRW:	Jason	CHKD	Jules	MATL:	Wu	DATE	18.04.2009
APPD:	Join			FINISH	Shieh	Sheet	2 from 2

