



### Technical Specification

#### Features

- Wire Wound Construction
- Excellent heat resistance
- Excellent environmental characteristics
- High reliability

#### Applications

- Power Supplies
- SCR and TRIAC Controls
- RFI Suppression
- Filters
- Switching Regulators

#### Dimensions

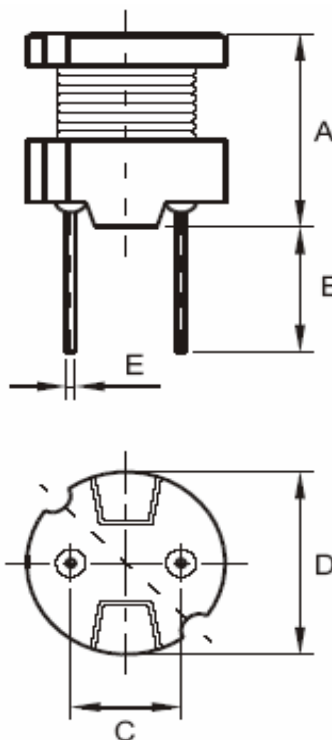

#### Technical Dimensions

A (mm)	B (mm)	C (mm)	D (mm)
9,5	5,0 +/-1,0	5,0 +/-0,3	8,3
E (mm)			
0,7			

### Electrical Characteristics

#### Technical Information

Testing LCR Bridge, measured @ 1KHz 0,1V HP4284A  
 Equivalent acceptacle  
 RDC. QuadTech 1880 Milliohmmer  
 IDC: Max. Lowers inductance by 10%  
 Operating Temperature: -40°C ~ +105°C  
 Storage Temperature: -40°C ~ +105°C  
 Solder Methods: Vapor Phase, Infrared Reflow  
 Shrink tube: Flame retardent UL type VW-1  
 Marking: Inductance and tolerance  
 Note: All specifications subject to change without notice.

Inductance	Inductance Code	IDC	DCR max.
1000µH	102	0,300A	1,840Ω

#### THT Radial Power Choke

Part No.: **S10R17**

Customer:

DRW:	Jason	CHKD	Jules	MATL:	Wu	DATE	18.04.2009
APPD:	Join			FINISH	Shieh	Sheet	1 from 2



**Soldering Profile**

**Classification Reflow Profile (JEDEC J-STD-020C)**

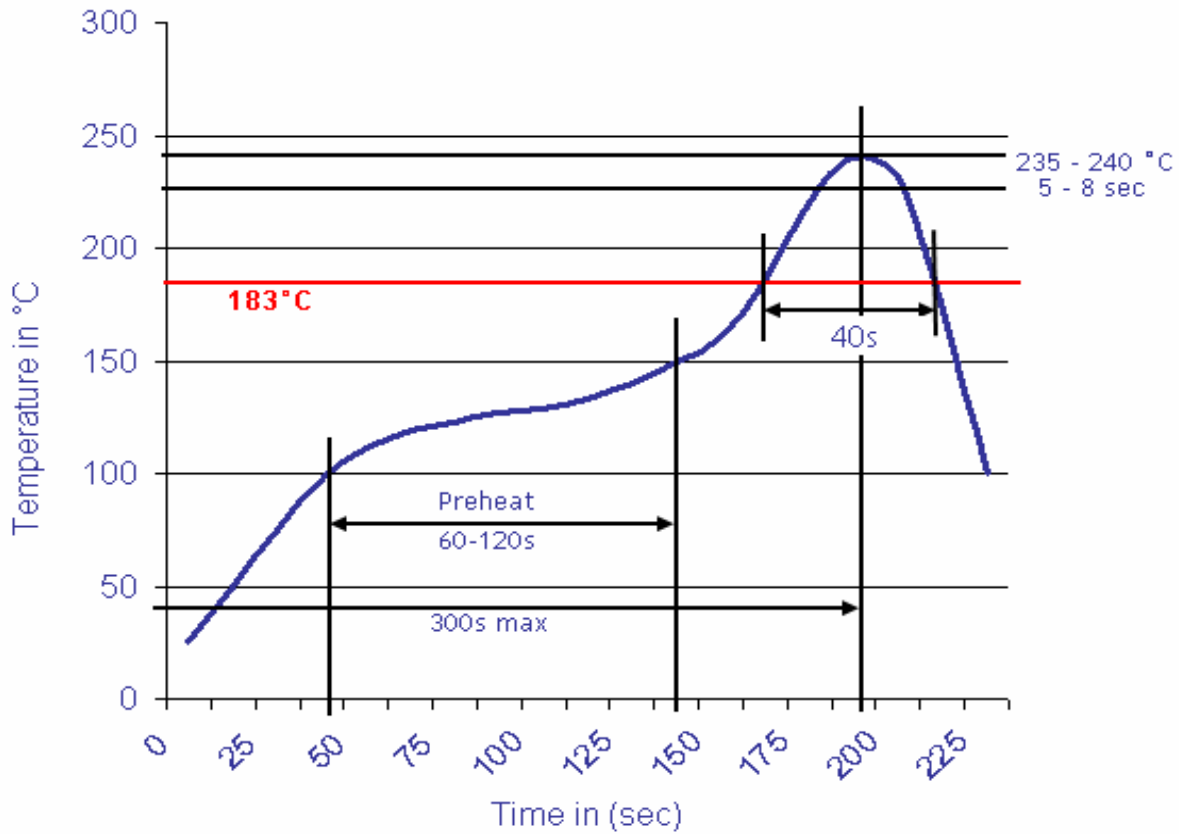

**Ordering Information**

Serie	Inductance	Tolerance	Lead Length	ROHS	Packing
<b>S10R17</b>	<b>102</b>	<b>M</b>	<b>50</b>	<b>R</b>	<b>BU10</b>

<b>102=</b> 1000µH	<b>M=</b> Tol. 20%	<b>50=</b> 5mm	<b>R=</b> ROHS conform	<b>BU=</b> Bulk Ware
	<b>K=</b> Tol. 10%	<b>15=</b> 15mm	<b>N=</b> NON ROHS conform	<b>TY=</b> Tray Package

<b>THT Radial Power Choke</b>	
Part No.:	<b>S10R17</b>
Customer:	

DRW:	Jason	CHKD	Jules	MATL:	Wu	DATE	18.04.2009
APPD:	Join			FINISH	Shieh	Sheet	2 from 2

