



Technical Specification

Features

Wire Wound Construction
 Excellent heat resistance
 Excellent environmental characteristics
 High reliability

Applications

Power Supplies
 SCR and TRIAC Controls
 RFI Suppression
 Filters
 Switching Regulators

Dimensions

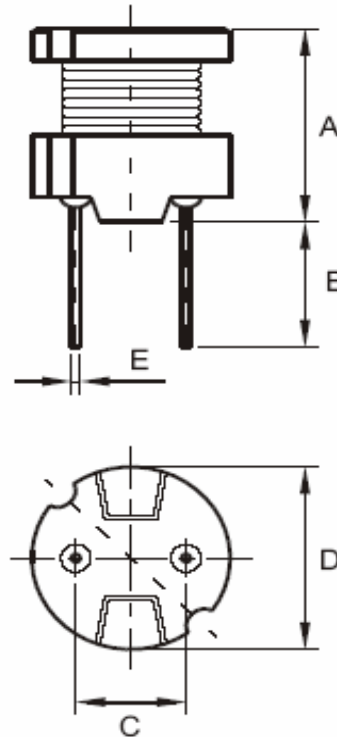

Technical Dimensions

A (mm)	B (mm)	C (mm)	D (mm)
7,5	5,0 +/-1,0	5,0 +/-0,3	8,3
E (mm)			
0,7			

Electrical Characteristics

Technical Information

Testing LCR Bridge, measured @ 1KHz 0,1V HP4284A
 Equivalent acceptacle
 RDC. QuadTech 1880 Milliohmmer
 IDC: Max. Lowers inductance by 10%
 Operating Temperature: -40°C ~ +105°C
 Storage Temperature: -40°C ~ +105°C
 Solder Methods: Vapor Phase, Infrared Reflow
 Shrink tube: Flame retardent UL type VW-1
 Marking: Inductance and tolerance
 Note: All specifications subject to change without notice.

Inductance	Inductance Code	IDC	DCR max.
1000µH	102	0,270A	2,940Ω

THT Radial Power Choke

Part No.: **S10R16**

Customer:

DRW:	Jason	CHKD	Jules	MATL:	Wu	DATE	15.04.2009
APPD:	Join			FINISH	Shieh	Sheet	1 from 2



Soldering Profile

Classification Reflow Profile (JEDEC J-STD-020C)

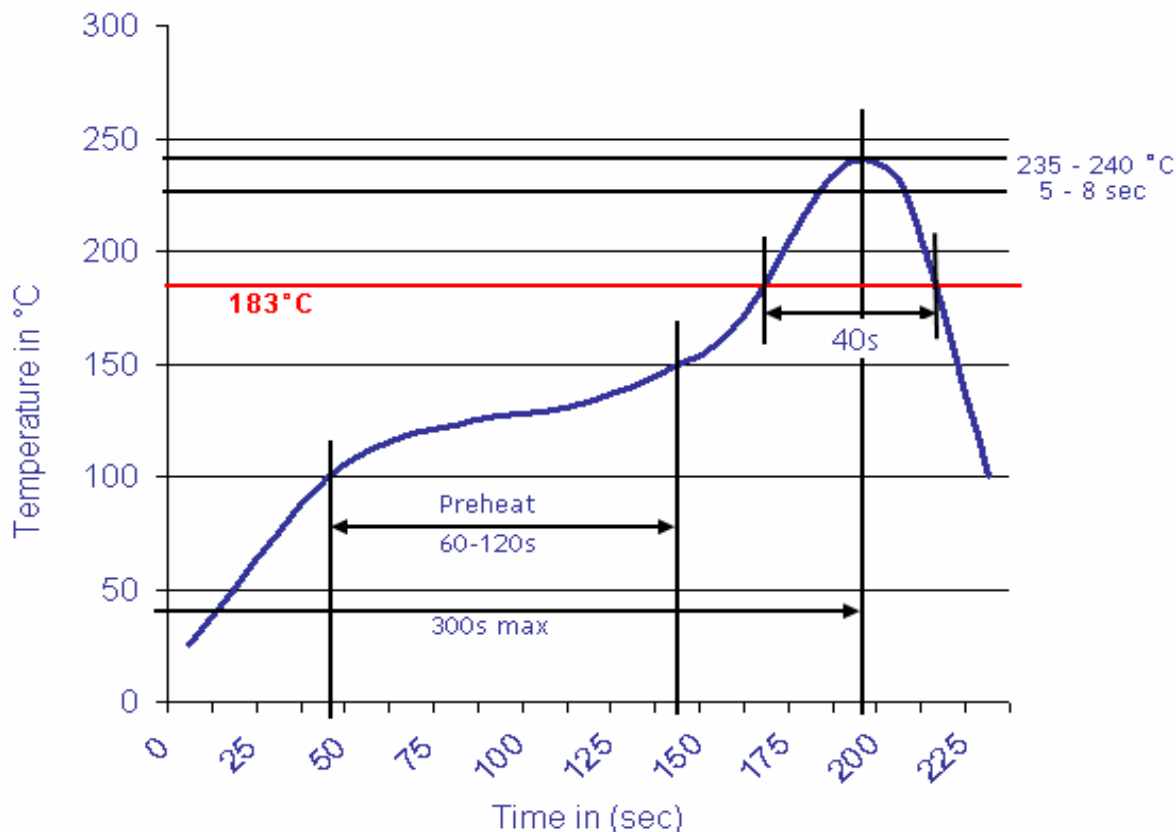

Ordering Information

Serie	Inductance	Tolerance	Lead Length	ROHS	Packing
S10R16	102	M	50	R	BU10

102= 1000µH	M= Tol. 20%	50= 5mm	R= ROHS conform	BU= Bulk Ware
	K= Tol. 10%	15= 15mm	N= NON ROHS conform	TY= Tray Package

THT Radial Power Choke	
Part No.:	S10R16
Customer:	

DRW:	Jason	CHKD	Jules	MATL:	Wu	DATE	15.04.2009
APPD:	Join			FINISH	Shieh	Sheet	2 from 2

