



Technical Specification

Features

- Magnetic Core
- Wire Wound construction
- Heat Resistant epoxy molded resin
- High reliability Ideal for automatic insertion
- Small Size
- Tolerance 10% is standard tighter tolerance available

Applications

- VCRs, PDP LCD, TV set
- Automotive Systms
- Computer Peripheral Equipment
- GPS, DC/DC Converter,
- XDSL Modem
- Electronic Games
- Mobile Communikations Equipment
- General Electronic Applications

Dimensions

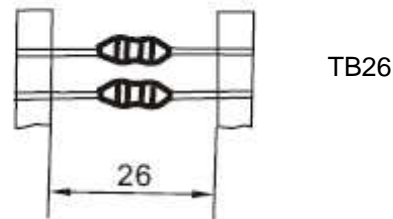
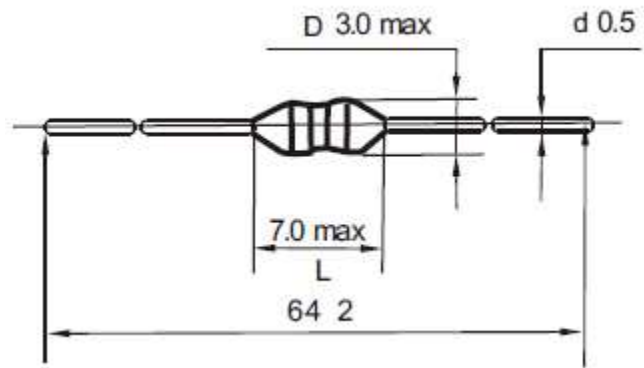

Electrical Characteristics

Technical Information

Inductance Testing: HP4284A, HP 4285A equivalent
 RDC: Quad Tech 1880 Milliohm meter
 Q-HP4342A
 SRF-HP4191A or HP4194A
 Rated Current L value drop 10% typ.at Idc against ist initial value.
 Temperature rise: 40 Max. Reference ambient temper.
 Solderability: 75° of the lead wire shall be covered
 SolderingMethods: Wave ; Reflow
 Operating Temperature: -25°C ~ +85°C
 Storage Temperature: -55°C ~ +105°C
 Terminal bending strength: 24,5N min.
 Moisture resistance: L/L 10% Q/Q 25%

Inductance	Inductance Code	IDC	DCR max.
270µH	271	0,065A	19,000Ω

	Q min.	L-Test Freq.	SRF
	50	0,796MHz	2,8MHz

THT AXIAL Standard Coated Inductors

Part No.: **S10A15**

Customer:

DRW:	James	CHKD	Jim	MATL:	Wim	DATE	06.08.2008
APPD:	Sarah			FINISH	Jeff	Sheet	1 from 2



Soldering Profile

Classification Reflow Profile (JEDEC J-STD-020C)



Ordering Information

Serie	Inductance	Tolerance	Function	ROHS	Packing
S10A15	271	K	N	R	TB52

271= 270µH	K= Tol. 10%	N= No function	R= ROHS conform	BU= Bulk Ware
	J= Tol. 5%		N=NON ROHS conform	TB26= Tape Box Package
				TB52= Tape Box Package

THT AXIAL Standard Coated Inductors

Part No.: **S10A15**

Customer:

DRW:	James	CHKD	Jim	MATL:	Wim	DATE	06.08.2008
APPD:	Sarah			FINISH	Jeff	Sheet	2 from 2

