



Technical Specification

Features

- Magnetic Core
- Wire Wound construction
- Heat Resistant epoxy molded resin
- High reliability Ideal for automatic insertion
- Small Size
- Tolerance 10% is standard tighter tolerance available

Applications

- VCRs, PDP LCD, TV set
- Automotive Systms
- Computer Peripheral Equipment
- GPS, DC/DC Converter,
- XDSL Modem
- Electronic Games
- Mobile Communikations Equipment
- General Electronic Applications

Dimensions

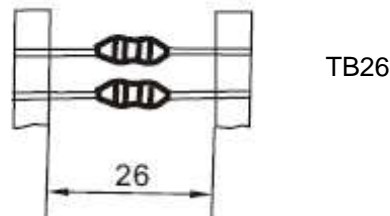
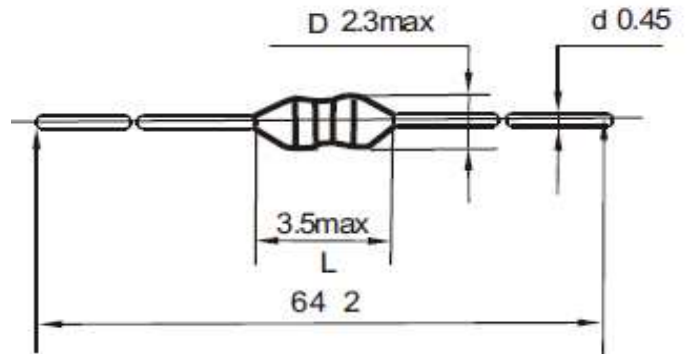

Electrical Characteristics

Technical Information

Inductance Testing: HP4284A, HP 4285A equivalent
 RDC: Quad Tech 1880 Milliohmeter
 Q-HP4342A
 SRF-HP4191A or HP4194A
 Rated Current L value drop 10% typ.at Idc against ist initial value.
 Temperature rise: 40 Max. Reference ambient temper.
 Solderability: 75° of the lead wire shall be covered
 SolderingMethods: Wave ; Reflow
 Operating Temperature: -25°C ~ +85°C
 Storage Temperature: -55°C ~ +105°C
 Terminal bending strength: 24,5N min.
 Moisture resistance: L/L 10% Q/Q 25%

| Inductance | Inductance Code | IDC | DCR max. |
|------------|-----------------|--------|----------|
| 47μH | 470 | 0,070A | 5,800Ω |

| | Q min. | L-Test Freq. | SRF |
|--|--------|--------------|-------|
| | 40 | 25,2MHz | 12MHz |

THT AXIAL Standard Coated Inductors

Part No.: **S10A13**

Customer:

| | | | | | | | |
|-------|-------|------|-----|--------|------|-------|------------|
| DRW: | James | CHKD | Jim | MATL: | Wim | DATE | 06.08.2008 |
| APPD: | Sarah | | | FINISH | Jeff | Sheet | 1 from 2 |



Soldering Profile

Classification Reflow Profile (JEDEC J-STD-020C)



Ordering Information

| Serie | Inductance | Tolerance | Function | ROHS | Packing |
|---------------|------------|-----------|----------|----------|-------------|
| S10A13 | 470 | K | N | R | TB52 |

| | | | | |
|------------------|--------------------|-----------------------|---------------------------|-------------------------------|
| 470= 47µH | K= Tol. 10% | N= No function | R= ROHS conform | BU= Bulk Ware |
| | J= Tol. 5% | | N=NON ROHS conform | TB26= Tape Box Package |
| | | | | TB52= Tape Box Package |

THT AXIAL Standard Coated Inductors

Part No.: **S10A13**

Customer:

| | | | | | | | |
|-------|-------|------|-----|--------|------|-------|------------|
| DRW: | James | CHKD | Jim | MATL: | Wim | DATE | 06.08.2008 |
| APPD: | Sarah | | | FINISH | Jeff | Sheet | 2 from 2 |

