



**Technical Specification**

**Features**

- Magnetic Core
- Wire Wound construction
- Heat Resistant epoxy molded resin
- High reliability Ideal for automatic insertion
- Small Size
- Tolerance 10% is standard tighter tolerance available

**Applications**

- VCRs, PDP LCD, TV set
- Automotive Systms
- Computer Peripheral Equipment
- GPS, DC/DC Converter,
- XDSL Modem
- Electronic Games
- Mobile Communikations Equipment
- General Electronic Applications

**Dimensions**

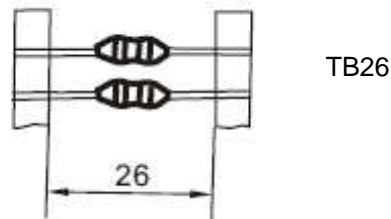
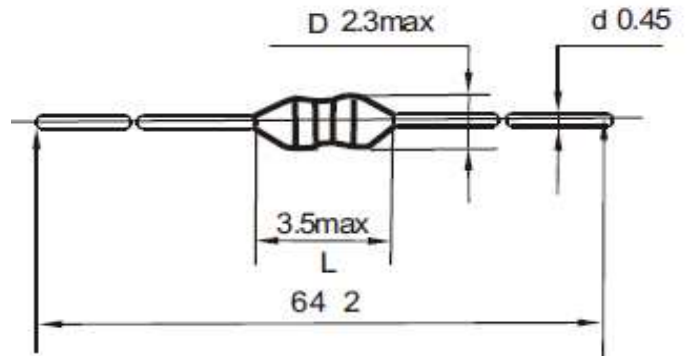

**Electrical Characteristics**

**Technical Information**

Inductance Testing: HP4284A, HP 4285A equivalent  
 RDC: Quad Tech 1880 Milliohmeter  
 Q-HP4342A  
 SRF-HP4191A or HP4194A  
 Rated Current L value drop 10% typ.at Idc against ist initial value.  
 Temperature rise: 40 Max. Reference ambient temper.  
 Solderability: 75° of the lead wire shall be covered  
 SolderingMethods: Wave ; Reflow  
 Operating Temperature: -25°C ~ +85°C  
 Storage Temperature: -55°C ~ +105°C  
 Terminal bending strength: 24,5N min.  
 Moisture resistance: L/L 10% Q/Q 25%

Inductance	Inductance Code	IDC	DCR max.
150μH	151	0,039A	16,000Ω

	Q min.	L-Test Freq.	SRF
	40	0,796MHz	6,0MHz

**THT AXIAL Standard Coated Inductors**

Part No.: **S10A13**

Customer:

DRW:	James	CHKD	Jim	MATL:	Wim	DATE	06.08.2008
APPD:	Sarah			FINISH	Jeff	Sheet	1 from 2



**Soldering Profile**

**Classification Reflow Profile (JEDEC J-STD-020C)**



**Ordering Information**

Serie	Inductance	Tolerance	Function	ROHS	Packing
<b>S10A13</b>	<b>151</b>	<b>K</b>	<b>N</b>	<b>R</b>	<b>TB52</b>

<b>151=</b> 150µH	<b>K=</b> Tol. 10%	<b>N=</b> No function	<b>R=</b> ROHS conform	<b>BU=</b> Bulk Ware
	<b>J=</b> Tol. 5%		<b>N=NON</b> ROHS conform	<b>TB26=</b> Tape Box Package
				<b>TB52=</b> Tape Box Package

**THT AXIAL Standard Coated Inductors**

Part No.: **S10A13**

Customer:

DRW:	James	CHKD	Jim	MATL:	Wim	DATE	06.08.2008
APPD:	Sarah			FINISH	Jeff	Sheet	2 from 2

