



Features

These Chokes are fitting with high-permeability toroid core (ferrite). They are mainly used in devices equipped with switched-mode power supplies, and in filters designed to prevent both the spread of parasitic noise within the device, and the effects of line noise on the device itself.

Technical Specification

Technical Data:

Rated Current:	referred to 250VAC 50/60Hz and 60°C ambient temperature
Rated Inductance:	at +20°C and 10kHz, 0,1mA.
Inductance tolerance:	.+ 50 -30%
Inductance loss:	<10% at DC initial loading with I _R
Testing Voltage:	1500V -50Hz, 2 sec, winding to winding
Climatic category:	DIN GKC (-40°C to +125°C; humidity cat.C).
DC resistance:	at +20°C
Derating operating current:	at +120°C ambient temperature I=0
Overtemperature of windings:	< 55°C
Max. permissible temperature of windings:	115°C%
Weight:	28gr.

Dimensions (vertical mounting)

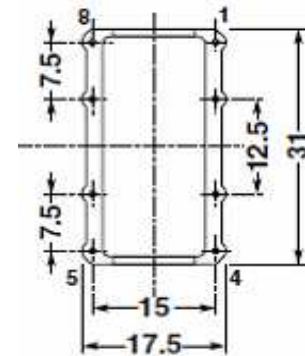
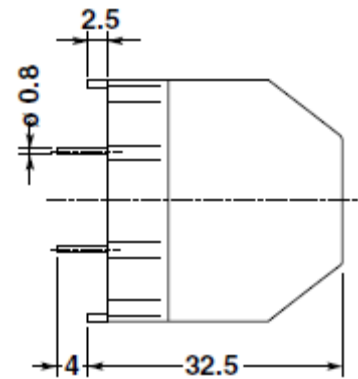

○ Pins
● Start of winding

Version B

The case are of flame-retardent plastic material in accordance with UL 94V-0
The choke are tested in accordance with EN 138100; EN60938-1

Rated current per winding (A)	Rated inductance per winding (mH)	DC resistance per winding (typical) mΩ
2,0	10,0	230

Potted Current Compensated Chokes

Part No.: **F12103**

Customer:

DRW:	Jason	CHKD	Jules	MATL:	Wu	DATE	04.07.2009
APPD:	Join			FINISH	Shieh	Sheet	1 from 2



Soldering Profile

Soldering Profile for Lead Soldering



Ordering Information

Serie	Tolerance	ROHS	Packing			
-------	-----------	------	---------	--	--	--

F12103	----	O	R	TY		
---------------	------	----------	----------	-----------	--	--

O= Tolerance +50% ~ -30%	R= ROHS conform N= NON ROHS conform	TY= Tray Packing
---------------------------------------	--	----------------------------

Potted Current Compensated Chokes	
Part No.:	F12103
Customer:	

DRW:	Jason	CHKD	Jules	MATL:	Wu	DATE	04.07.2009
APPD:	Join			FINISH	Shieh	Sheet	2 from 2