



### Features

These Chokes are fitting with high-permeability toroid core ( ferrite).  
They are mainly used in devices equipped with switched-mode power supplies, and in filters designed to prevent both the spread of parasitic noise within the device, and the effects of line noise on the device itself.

### Technical Specification

#### Technical Data:

Rated Current:	referred to 250VAC 50/60Hz and 60°C ambient temperature
Rated Inductance:	at +20°C and 10kHz, 0,1mA.
Inductance tolerance:	.+ 50 -30%
Inductance loss:	<10% at DC initial loading with I <sub>R</sub>
Testing Voltage:	1500V -50Hz, 2 sec, winding to winding
Climatic category:	DIN GKC ( -40°C to +125°C; humidity cat.C).
DC resistance:	at +20°C
Derating operating current:	at +120°C ambient temperature I=0
Overtemperature of windings:	< 55°C
Max. permissible temperature of windings:	115°C%
Weight:	28gr.

#### Dimensions ( horizontal mounting )

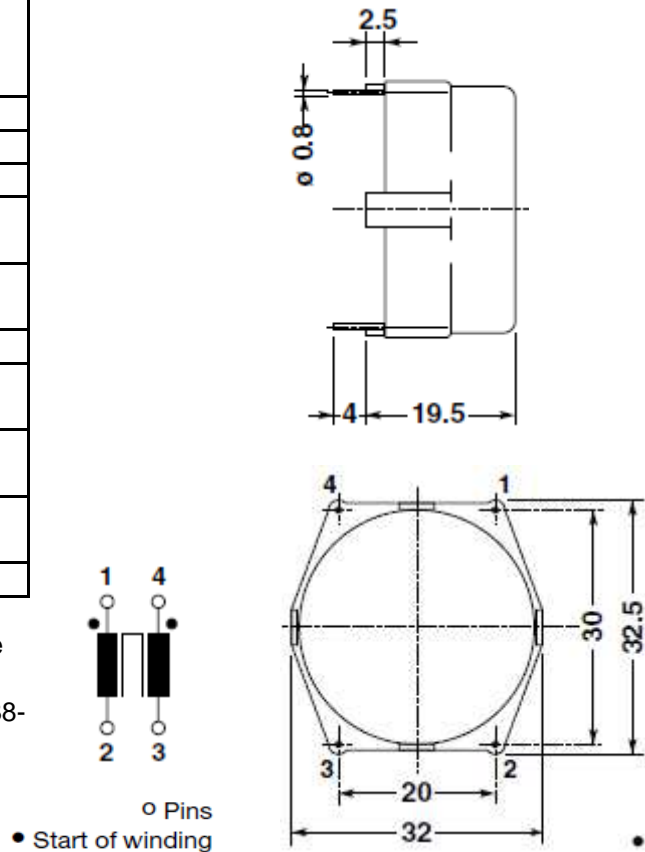

The case are of flame-retardent plastic material in accordance with UL 94V-0  
The choke are tested in accordance with EN 138100; EN60938-1

Rated current per winding (A)	Rated inductance per winding (mH)	DC resistance per winding (typical) mΩ
4,0	3,3	68

### Potted Current Compensated Chokes

Part No.: **F11051**

Customer:

DRW:	Jason	CHKD	Jules	MATL:	Wu	DATE	04.07.2009
APPD:	Join			FINISH	Shieh	Sheet	1 from 2

Copyright by EDCON-COMPONENTS H.Schmitt 20.6.2008

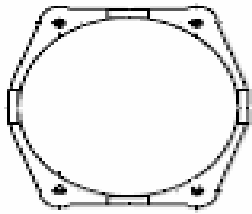

**Soldering Profile**

**Soldering Profile for Lead Soldering**



**Ordering Information**

Serie	Tolerance	ROHS	Packing			
-------	-----------	------	---------	--	--	--

<b>F11051</b>	----	<b>O</b>	<b>R</b>	<b>TY</b>		
---------------	------	----------	----------	-----------	--	--

<b>O</b> = Tolerance +50% ~ -30%	<b>R</b> = ROHS conform <b>N</b> =NON ROHS conform	<b>TY</b> = Tray Packing
--	---	-----------------------------

<b>Potted Current Compensated Chokes</b>	
Part No.:	<b>F11051</b>
Customer:	

DRW:	Jason	CHKD	Jules	MATL:	Wu	DATE	04.07.2009
APPD:	Join			FINISH	Shieh	Sheet	2 from 2