

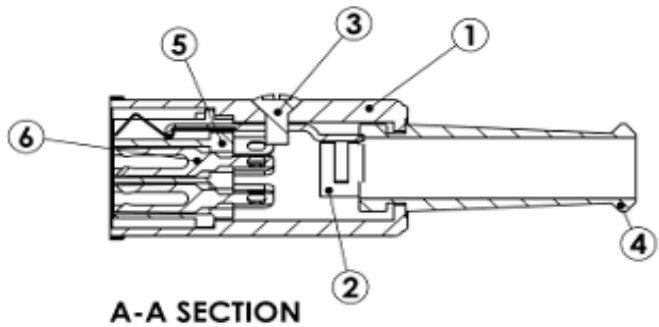

Technical Specification

Shell Cover:	Zn Alloy Nickel plated
T- Holder:	Steel Nickel plated
Set Screw:	Steel Nickel plated
Strain Boot:	PVC
Housing:	ABS
Terminals:	Copper Silver plated
GND Contactor:	Phosphor Bronze Nickel plated
Rating:	100VAC 1A max.
Contact Resistance:	Pin 30m Ohm max. Shell 50m Ohm max.
Insulation Resistance:	100M Ohm at 500VDC min.
Voltage Withstanding:	250VAC for 1 minute

Pos.

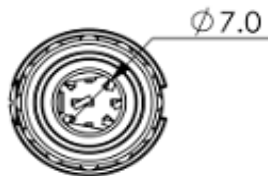
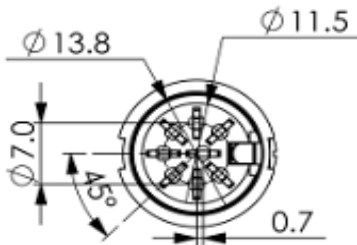
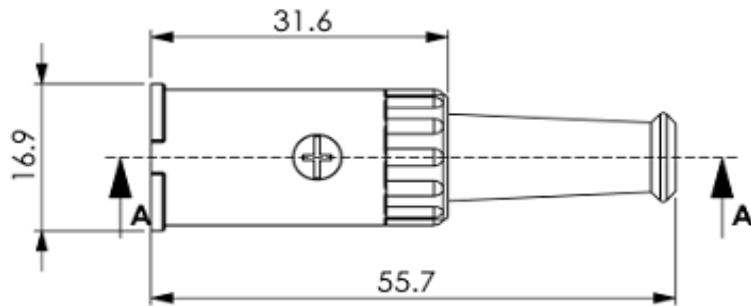

Ordering Information

Serie	Pos.	ROHS	Packing			
T20D070	6	R	B			

	N= non ROHS	B= Bulk-Ware	
	R= ROHS	IN= individuell	

DIN FEMALE METAL COVER W. PUSH LOCKING	
Part No.:	T20D070
Customer:	

DRW:	Jason	CHKD	Jules	MATL:	Wu	DATE	01.06.2007
APPD:	Join			FINISH	Shieh	Sheet	1 from 1

Copyright by EDCON-COMPONENTS H.Schmitt 20.6.2008