



Technical Specification



Pos.

Shield Cover:
Housing:
GND Contactor:
Terminals:

Brass Nickel plated
ABS
Phoephor Bronze Nickel plated
Copper Nickel plated

Rating:
Contact Resistance:

100VAC 1A max.
Pin 30m Ohm max.
Shell 50m Ohm max.

Insulation Resistance:
Voltage Withstanding:

100M Ohm at 500VDC min.
250VAC for 1 minute

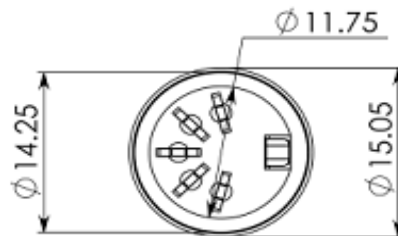
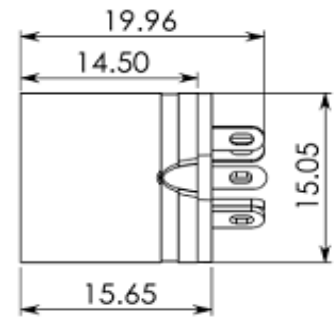
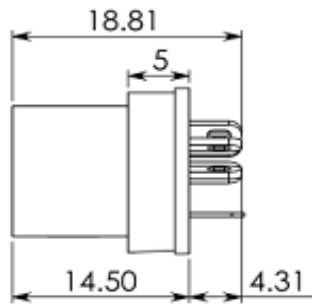

Ordering Information

Serie	Pos.	ROHS	Packing			
T20D002	4	R	B			

	N= non ROHS	B= Bulk-Ware	
	R= ROHS	IN= individuell	

DIN CABLE MOLDING METALL COVER	
Part No.:	T20D002
Customer:	

DRW:	Jason	CHKD	Jules	MATL:	Wu	DATE	01.06.2007
APPD:	Join			FINISH	Shieh	Sheet	1 from 1