

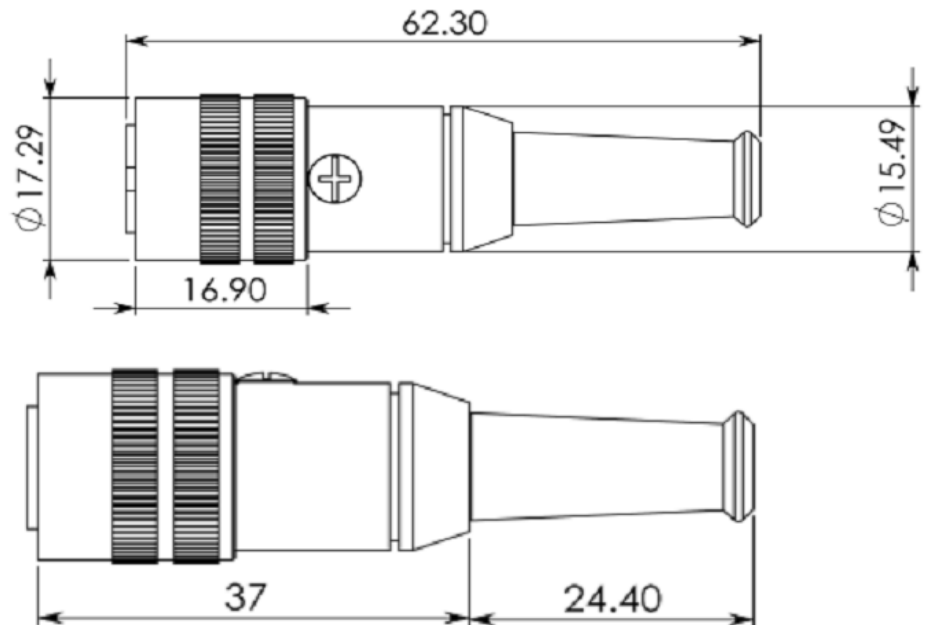

Pos.

**Technical Specification**

Shell Cover:	Brass Nickel plated
Screw Cap:	Brass Nickel plated
T-Hoder:	Steel Nickel plated
Spring:	Steel Nickel plated
Setscrew:	Steel Nickel plated
Strain Boot:	PVC
Housing:	ABS
Terminals:	Brass Nickel plated
Rating:	100VAC 1A max.
Contact Resistance:	Pin 30m Ohm max. Shell 50m Ohm max.
Insulation Resistance:	100M Ohm at 500VDC min.
Voltage Withstanding:	250VAC for 1 minute

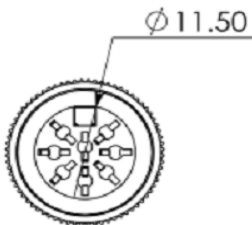

**Ordering Information**

Serie	Pos.	ROHS	Packing			
T20C173	3	R	B			

	N= non ROHS	B= Bulk-Ware	
	R= ROHS	IN= individuell	

DIN CABLE METALL COVER W. M16 LOCKING	
Part No.:	<b>T20C173</b>
Customer:	

DRW:	Jason	CHKD	Jules	MATL:	Wu	DATE	01.06.2007
APPD:	Join			FINISH	Shieh	Sheet	1 from 1