

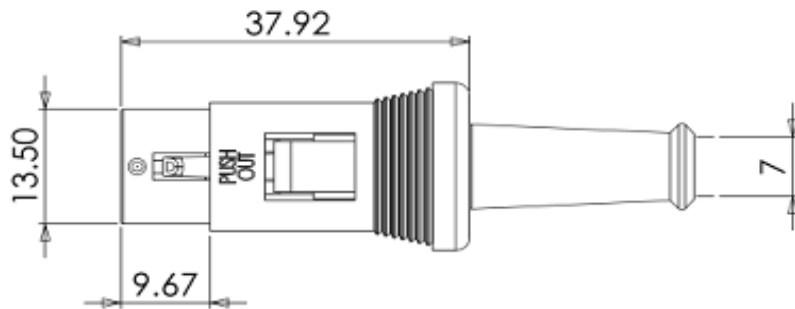

Pos.

Technical Specification

Shell Cover:	PA6
Strain Boot:	PVC
Shield cover A:	Steel nickel plated
Shield cover B:	Steel nickel plated
Spring Hook:	Steel nickel plated
Housing:	ABS
Terminals:	Brass Silver plated
Rating:	100VAC 1A max.
Contact Resistance:	Pin 30m Ohm max. Shell 50m Ohm max.
Insulation Resistance:	100M Ohm at 500VDC min.
Voltage Withstanding:	250VAC for 1 minute

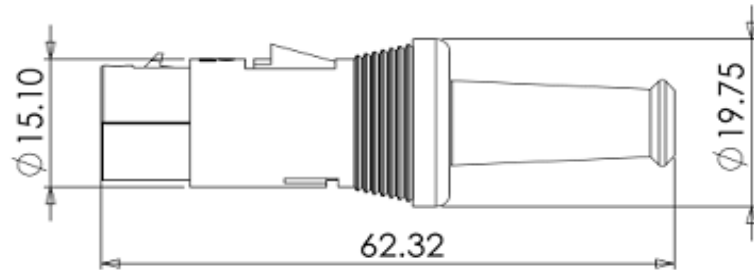

Ordering Information

Serie	Pos.	ROHS	Packing			
T20C053	7	R	B			

	N= non ROHS	B= Bulk-Ware	
	R= ROHS	IN= individuell	

DIN CABLE PLUG PLASTIC COVER WITH LOCK	
Part No.:	T20C053
Customer:	

DRW:	Jason	CHKD	Jules	MATL:	Wu	DATE	01.06.2007
APPD:	Join			FINISH	Shieh	Sheet	1 from 1