



Technical Specification



Pos.

Shell Cover:	PA6
Screw cap:	PA6
Shield cover A	Steel nickel plated
Shield cover B	Steel nickel plated
O Ring	Brass Nickel plated
Srew	Brass Nickel plated
Housing:	ABS
Terminals:	Brass Silver plated
Rating:	100VAC 1A max.
Contact Resistance:	Pin 30m Ohm max. Shell 50m Ohm max.
Insulation Resistance:	100M Ohm at 500VDC min.
Voltage Withstanding:	250VAC for 1 minute

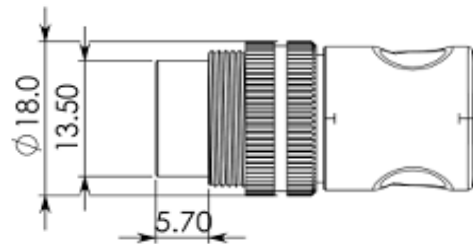
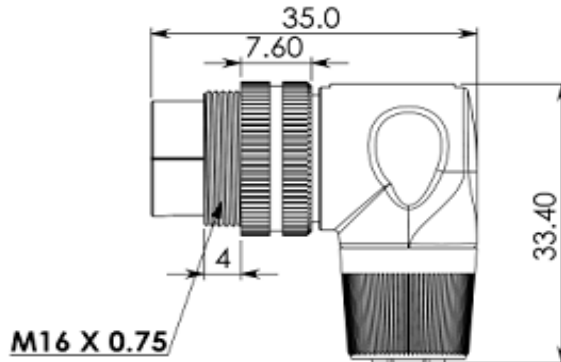
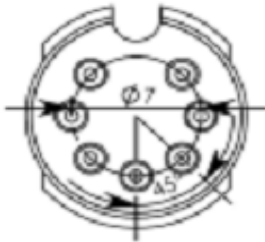

Ordering Information

Serie	Pos.	ROHS	Packing			
T20C035	7	R	B			

	N= non ROHS	B= Bulk-Ware	
	R= ROHS	IN= individuell	

DIN CABLE PLUG PLASTIC COVER RIGHT ANGLE M16	
Part No.:	T20C035
Customer:	

DRW:	Jason	CHKD	Jules	MATL:	Wu	DATE	01.06.2007
APPD:	Join			FINISH	Shieh	Sheet	1 from 1