

EDCON-COMPONENTS



Specifications

Material Housing:	Thermoplastic High Temp UL94V-0 Color Natural
Material Latch:	Thermoplastic High Temp UL94V-0 Color Black
Terminal:	Copper Alloy
Fitting Nail:	Copper Alloy
Plating Finish:	Matt Tin or Gold flash overall
Fitting Nail:	Matt Tin overall
Electrical:	
Current Rating:	0,5A/AC/DC
Voltage Rating:	50V AC/DC
Temperature Range:	- 25°C ~ +85°C
Contact Resistance:	20m Ohm max.
Insulation Resistance:	500M Ohm min.
Withstanding Voltage:	200V AC/Minute
Relative Humidity:	93% max. / 40°C

P.C.B Layout

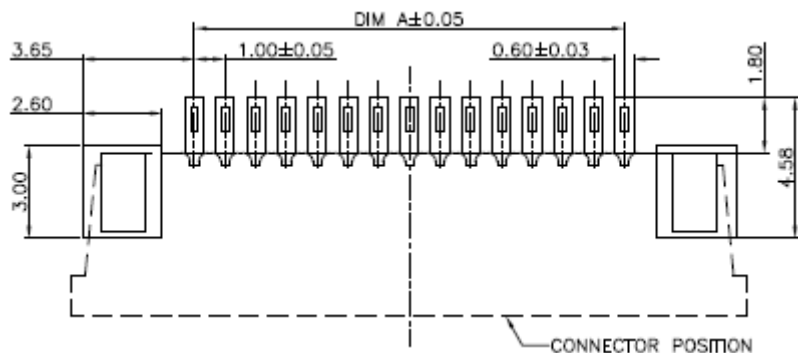

Drawing

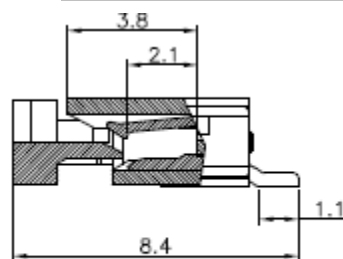

SECTION A-A
SCALE 1:1

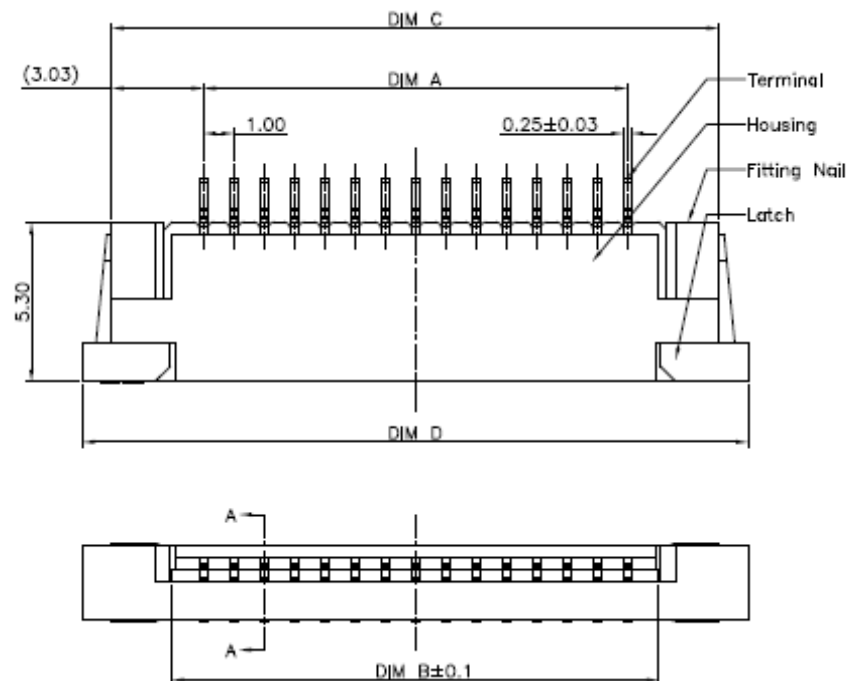
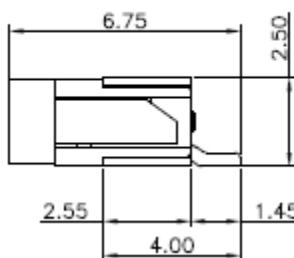

**FFC/FPC Connector Pitch
1,0mm UPPER Contact**

Part No.: **T28F017**

DRW:	Jason	CHKD	Wilson	MATL:	Wilson	TOLERANCE	Mason	DATE	12.04.2014
APPD:	Schumi			FINISH	Jamy		Sheet No.		1 from 4

Customer:
email: info@edcon-components.com

EDCON-COMPONENTS



Pin Code length table free configuration

Dimension (mm)				
Pos.	A	B	C	D
4	3,00	5,10	9,05	11,00
5	4,00	6,10	10,05	12,00
6	5,00	7,10	11,05	13,00
7	6,00	8,10	12,05	14,00
8	7,00	9,10	13,05	15,00
9	8,00	10,10	14,05	16,00
10	9,00	11,10	15,05	17,00
11	10,00	12,10	16,05	18,00
12	11,00	13,10	17,05	19,00
13	12,00	14,10	18,05	20,00
14	13,00	15,10	19,05	21,00
15	14,00	16,10	20,05	22,00
16	15,00	17,10	21,05	23,00
17	16,00	18,10	22,05	24,00
18	17,00	19,10	23,05	25,00
19	18,00	20,10	24,05	26,00
20	19,00	21,10	25,05	27,00
21	20,00	22,10	26,05	28,00
22	21,00	23,10	27,05	29,00
23	22,00	24,10	28,05	30,00
24	23,00	25,10	29,05	31,00
25	24,00	26,10	30,05	32,00
26	25,00	27,10	31,05	33,00
27	26,00	28,10	32,05	34,00
28	27,00	29,10	33,05	35,00
29	28,00	30,10	34,05	36,00
30	29,00	31,10	35,05	37,00

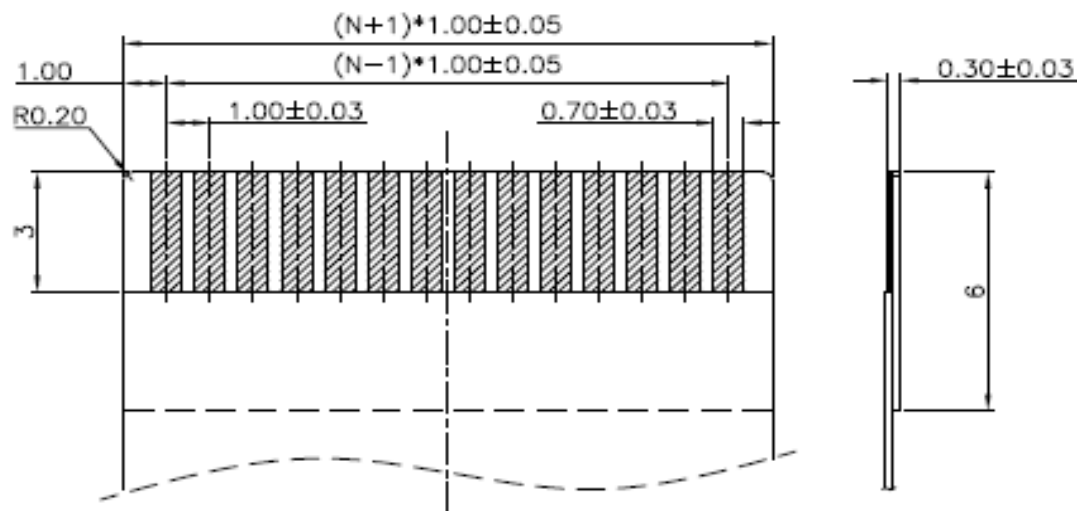

**FFC/FPC Connector Pitch
1,0mm UPPER Contact**

Part No.: **T28F017**

Customer:

DRW:	Jason	CHKD	Wilson	MATL:	Wilson	TOLERANCE	Mason	DATE	12.04.2014
APPD:	Schumi			FINISH	Jamy		Sheet No.	2 from 4	

EDCON-COMPONENTS



Ordering Informations

Serie	No. of Pos.	Construction	Contact Plating	Material	Special function	Special function	ROHS	Packing		
T28F017	xx	RS	T0	TP	0	0	R	TR		

XX= total		G0 = Gold Flash		0 = No function	0 = No function	N =NON ROHS conform	
		T0 = Tin plated	TP = themoplastic UL94V-0				TU = Tube
							R =ROHS conform
		RS = Right angle SMT					

**FFC/FPC Connector Pitch
1,0mm UPPER Contact**

Part No.: **T28F017**

DRW:	Jason	CHKD	Wilson	MATL:	Wilson	TOLERANCE	Mason	DATE	12.04.2014
APPD:	Schumi			FINISH	Jamy		Sheet No.		3 from 4

Customer:
email: info@edcon-components.com



Lead Solder Curve

Lead free Solder Curve

Classification Reflow Profile (JEDEC J-STD-020C)

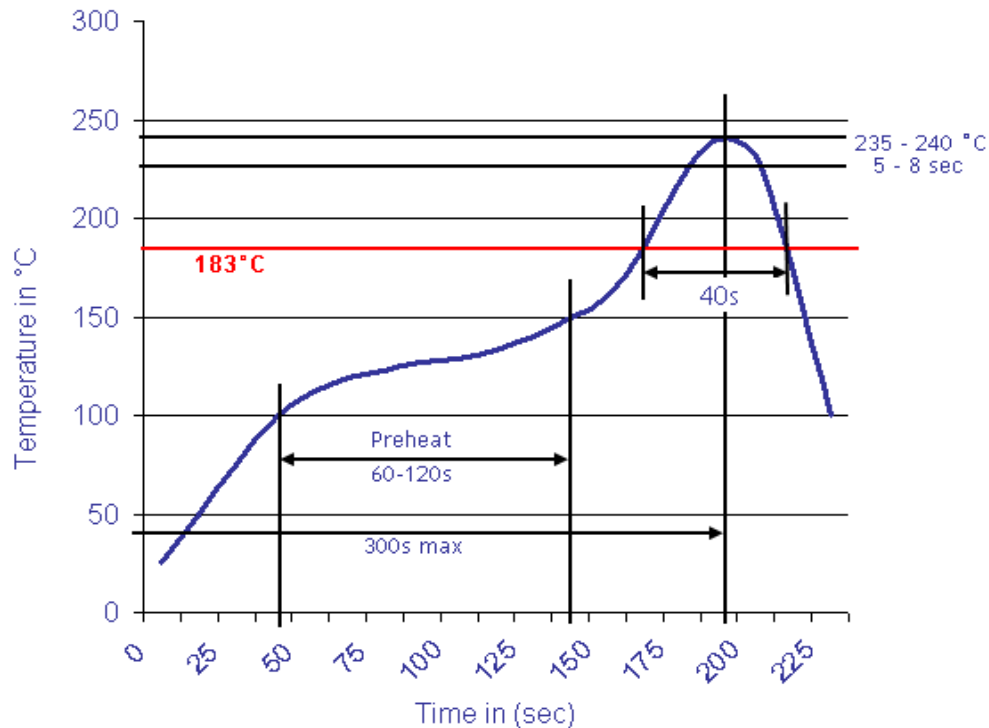

Classification Reflow Profile (JEDEC J-STD-020C)

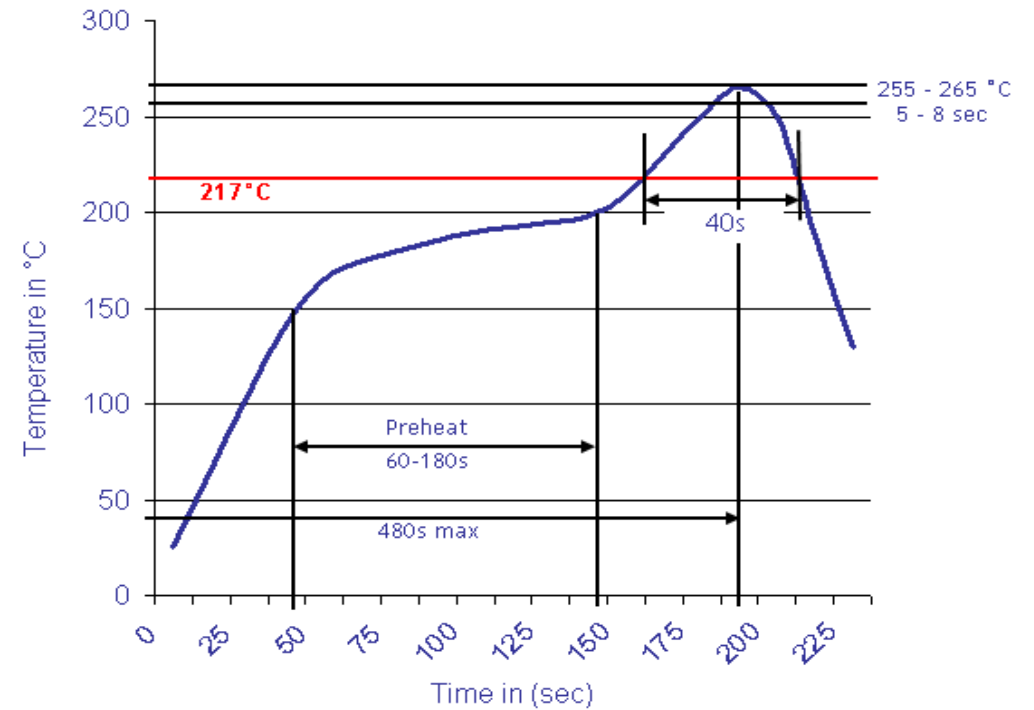

**FFC/FPC Connector Pitch
1,0mm UPPER Contact**

Part No.: **T28F017**

DRW:	Jason	CHKD	Wilson	MATL:	Wilson	TOLERANCE	Mason	DATE	12.04.2014
APPD:	Schumi			FINISH	Jamy		Sheet No.	4 from 4	Customer:

