

### Technical Specification

Insulator:	Black glass filled polyester PPS-GF-30-FR
Flammability:	UL 94V-0
Sleeve:	Brass CuZn 36Pb3 (36000)
Contact Clip (3finger):	Beryllium Copper (C17200)
Mating Pin: ( Ø )	0,40 to 0,56mm
Forces:	polished steel gauge(Ø)0,43mm
.-Insertion:	2N typ.
.-Withdrawel:	1N typ.
Mechanical Life:	min 500 cycles
Rated Current:	3A
Contact Resistance:	max. 10m Ohm
Dielectric Strength:	min 1000V rms
Pin length L=	13,0mm
Maximal position of deliver:	2
Maximal position of deliver:	40

### Technical Drawing

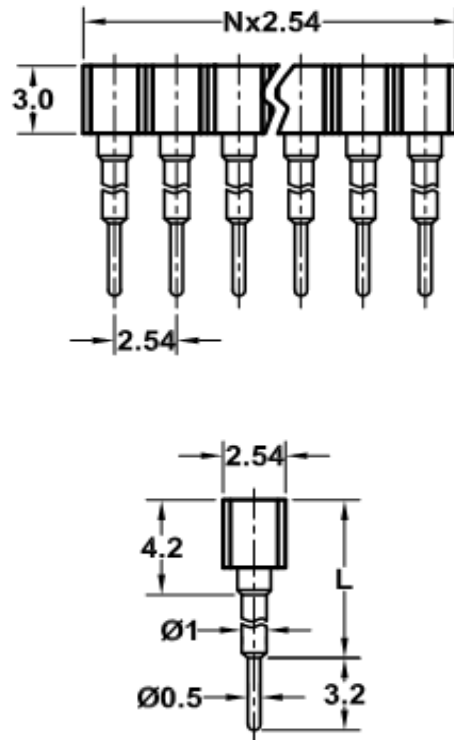

### Ordering Information

Serie	No. of Pos.	Solder Pin Plating	Inner Clip Plating	ROHS	Packing
<b>T40299</b>	<b>40</b>	<b>A</b>	<b>3</b>	<b>R</b>	<b>B1</b>

<b>2 ~ 40</b>	<b>A= Tin 150µ"</b> (Standard)	<b>1= Tin 150µ"</b> <b>2= Tin 200µ"</b>	<b>R= ROHS conform</b> <b>N= NON ROHS conform</b>	<b>B1= Bulk 100PCS</b>
	<b>B= Tin 200µ"</b>	<b>3= GF (Standard)</b>		
	<b>C= GF</b>	<b>4= Gold 2µ"</b>		
	<b>D= Gold 2µ"</b>	<b>5= Gold 3µ"</b>		
	<b>E= Gold 3µ"</b>	<b>6= Gold 10µ"</b>		
	<b>F= Gold 10µ"</b>	<b>7= Gold 15µ"</b>		
	<b>G= Gold 15µ"</b>	<b>8=Special</b>		
	<b>H=Special</b>			

**Machined Contact Pitch  
2,54mm**

Part No.: **T40299**

Customer:

DRW:	Jason	CHKD	Jules	MATL:	Wu	DATE	21.07.2017
APPD:	Join			FINISH	Shieh	Sheet	1 from 1