

### Technical Specification

Insulator:	Black glass filled polyester PPS-GF-30-FR
Flammability:	UL 94V-0
Sleeve:	Brass CuZn 36Pb3 (36000)
Mating Pin: ( Ø )	0,50 / 0,60 mm
Mechanical Life:	min 500 cycles
Rated Current:	3A
Contact Resistance:	max. 10m Ohm
Dielectric Strength:	min 1000V rms
Minimal position of deliver:	4
Maximal position of deliver:	80

### Technical Drawing

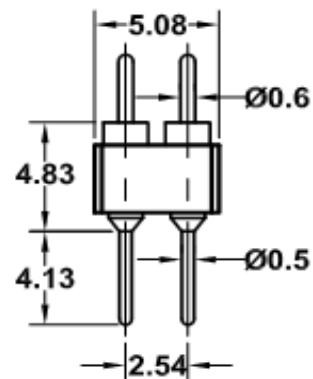
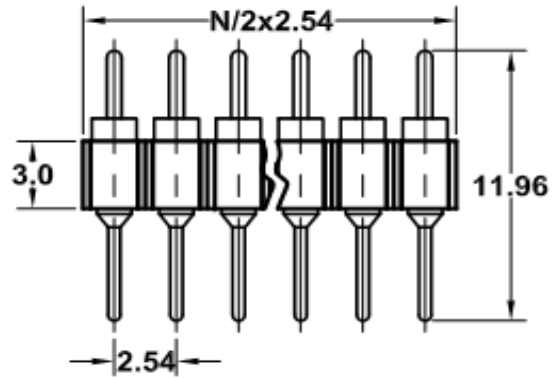

### Ordering Information

Serie	No. of Pos.	Solder Pin Plating	ROHS	Packing		
-------	-------------	--------------------	------	---------	--	--

<b>T40175</b>	<b>80</b>	<b>A</b>	<b>R</b>	<b>B1</b>		
---------------	-----------	----------	----------	-----------	--	--

<b>04 ~ 80</b>	<b>A=</b> Tin 150µ" (Standard)	<b>R=</b> ROHS conform	<b>B1=</b> Bulk 100PCS
	<b>B=</b> Tin 200µ"	<b>N=</b> NON ROHS conform	<b>Ix =</b> individuall
	<b>C=</b> GF		
	<b>D=</b> Gold 2µ"		
	<b>E=</b> Gold 3µ"		
	<b>F=</b> Gold 10µ"		
	<b>G=</b> Gold 15µ"		
	<b>H=</b> Special		

**Machined Contact Pitch  
2,54mm**

Part No.: **T40175**

Customer:

DRW:	Jason	CHKD	Jules	MATL:	Wu	DATE	06.06.2009
APPD:	Join			FINISH	Shieh	Sheet	1 from 1