

Technical Specification

Insulator:	Black glass filled polyester PPS-GF-30-FR
Flammability:	UL 94V-0
Sleeve:	Brass CuZn 36Pb3 (36000)
Contact Clip (3finger):	Beryllium Copper (C17200)
Mating Pin: (Ø)	0,40 to 0,56mm
Forces:	polished steel gauge(Ø)0,43mm
.-Insertion:	2N typ.
.-Withdrawel:	1N typ.
Mechanical Life:	min 500 cycles
Rated Current:	3A
Contact Resistance:	max. 10m Ohm
Dielectric Strength:	min 1000V rms
Pin length L=	12,0mm
Maximal position of deliver:	2
Maximal position of deliver:	40

Technical Drawing

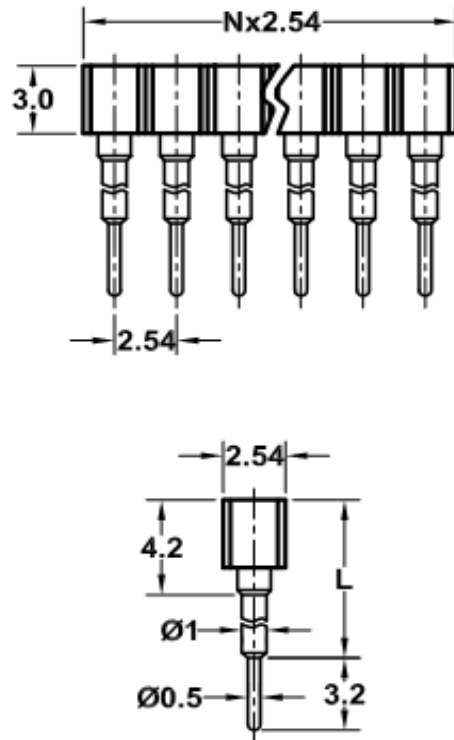

Ordering Information

Serie	No. of Pos.	Solder Pin Plating	Inner Clip Plating	ROHS	Packing
T40076	40	A	3	R	B1

2 ~ 40	A= Tin 150µ" (Standard)	1= Tin 150µ" 2= Tin 200µ"	R= ROHS conform N= NON ROHS conform	B1= Bulk 100PCS TR = Tape/Reel w. Pic and Place Pad TU = Tupe w. Pic and Place Pad
	B= Tin 200µ"	3= GF (Standard)		
	C= GF	4= Gold 2µ"		
	D= Gold 2µ"	5= Gold 3µ"		
	E= Gold 3µ"	6= Gold 10µ"		
	F= Gold 10µ"	7= Gold 15µ"		
	G= Gold 15µ"	8=Special		
	H=Special			

**Machined Contact Pitch
2,54mm**

Part No.: **T40076**

Customer:

DRW:	Jason	CHKD	Jules	MATL:	Wu	DATE	06.06.2009
APPD:	Join			FINISH	Shieh	Sheet	1 from 1