

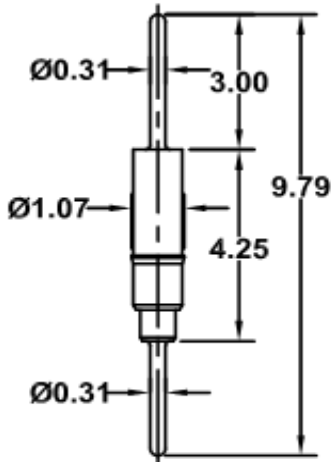

**Technical Drawing**



**Ordering Information**

Serie	Solder Pin Plating	Contact Clip Plating	ROHS	Packing
<b>T34068</b>	<b>A</b>	<b>3</b>	<b>R</b>	<b>BU1</b>

<b>A=</b> Tin 150µ" (Standard)	<b>1=</b> Tin 150µ" <b>2=</b> Tin 200µ"	<b>R=</b> ROHS conform	<b>BU1=</b> 1000PCS / BAG
<b>B=</b> Tin 200µ"	<b>3=</b> GF (Standard)		
<b>C=</b> GF	<b>4=</b> Gold 2µ"		
<b>D=</b> Gold 2µ"	<b>5=</b> Gold 3µ"		
<b>E=</b> Gold 3µ"	<b>6=</b> Gold 10µ"		
<b>F=</b> Gold 10µ"	<b>7=</b> Gold 15µ"		
<b>G=</b> Gold 15µ"	<b>8=</b> Special		
<b>H=</b> Special			

<b>Machined Single Contact</b>	
Part No.:	<b>T34068</b>
Customer:	

DRW:	Jason	CHKD	Jules	MATL:	Wu	DATE	06.06.2007
APPD:	Join			FINISH	Shieh	Sheet	1 from 1