

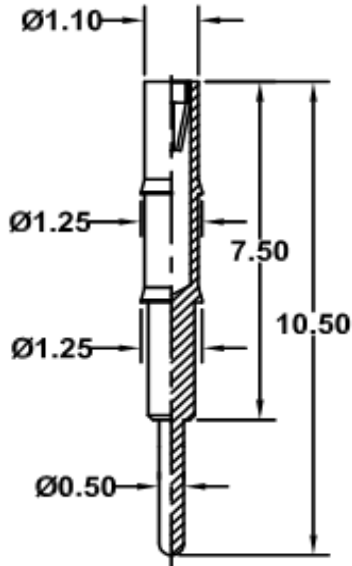

Technical Drawing



Ordering Information

Serie	Solder Pin Plating	Contact Clip Plating	ROHS	Packing
T34058	A	3	R	BU1

A= Tin 150µ" (Standard)	1= Tin 150µ" 2= Tin 200µ"	R= ROHS conform	BU1= 1000PCS / BAG
B= Tin 200µ"	3= GF (Standard)		
C= GF	4= Gold 2µ"		
D= Gold 2µ"	5= Gold 3µ"		
E= Gold 3µ"	6= Gold 10µ"		
F= Gold 10µ"	7= Gold 15µ"		
G= Gold 15µ"	8= Special		
H= Special			

Machined Single Contact	
Part No.:	T34058
Customer:	

DRW:	Jason	CHKD	Jules	MATL:	Wu	DATE	06.06.2007
APPD:	Join			FINISH	Shieh	Sheet	1 from 1