

Pitch 2,54 x XXX mm

Technical Specifications:

Insulator:	Black glass filled polyester
	PBT-GF30-FR
Flammability:	UL94V-0
Sleeve:	Brass CuZn 36pb3 (36000)
Mating Pin:	0,47 / 0,67mm
Mechanical Life:	min 100 cycles
Rated Current:	1A
Contact Resistance:	max. 10 milli Ohm
Dielectric strength:	min 1000V rms
Pin Length:	L=27,4mm
Temp. Range:	.-40°C to + 105°C

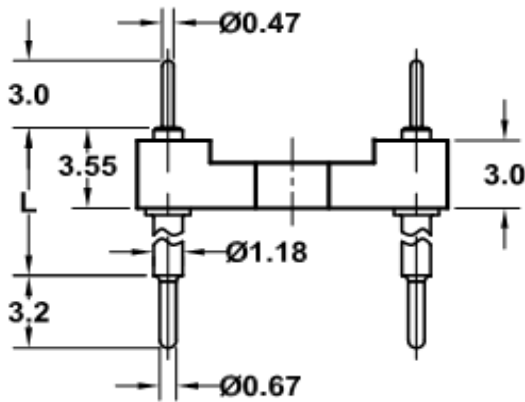
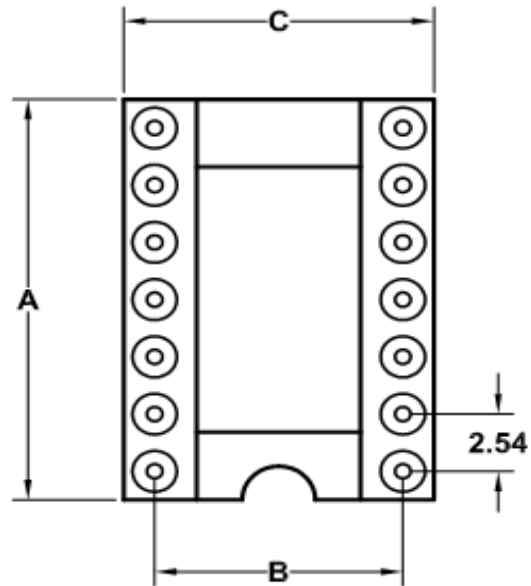

**Machined Contact Dual
 Inline Socket**

Part No.: **T34027**

Customer:

DRW:	Jason	CHKD	Jules	MATL:	Wu	DATE	06.06.2009
APPD:	Join			FINISH	Shieh	Sheet	1 from 2

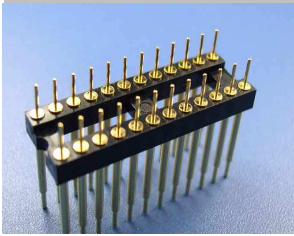

Order Code	No of Pos.	A	B	C
		(mm)	(mm)	(mm)
306	6	7,6	7,62	10,1
308	8	10,1	7,62	10,1
310	10	12,6	7,62	10,1
312	12	15,2	7,62	10,1
314	14	17,7	7,62	10,1
316	16	20,3	7,62	10,1
318	18	22,8	7,62	10,1
320	20	25,3	7,62	10,1
322	22	27,8	7,62	10,1
324	24	30,4	7,62	10,1
328	28	35,5	7,62	10,1
420	20	25,4	10,16	12,6
422	22	27,8	10,16	12,6
424	24	30,4	10,16	12,6
428	28	35,5	10,16	12,6
432	32	40,6	10,16	12,6
624	24	30,5	15,24	17,7
628	28	35,5	15,24	17,7
632	32	40,6	15,24	17,7
636	36	45,7	15,24	17,7
640	40	50,8	15,24	17,7
642	42	53,3	15,24	17,7
648	48	60,9	15,24	17,7
650	50	63,5	15,24	17,7
652	52	66,0	15,24	17,7
950	50	63,5	22,86	25,3
952	52	66,0	22,86	25,3
964	64	81,2	22,86	25,3

Ordering Information

Serie	Order Code	Solder Pin Plating	Contact Clip Plating	ROHS	Packing	
T34027	xxx	A	3	R	TU	

look table	A= Tin 150µ" (Standard)	1= Tin 150µ" 2= Tin 200µ"	R= ROHS conform	TU= TUPE Packing
	B= Tin 200µ"	3= GF (Standard)	N= NON ROHS conform	
	C= GF	4= Gold 2µ"		
	D= Gold 2µ"	5= Gold 3µ"		
	E= Gold 3µ"	6= Gold 10µ"		
	F= Gold 10µ"	7= Gold 15µ"		
	G= Gold 15µ"	8=Special		
	H=Special			

Machined Contact Dual Inline Socket	
Part No.:	T34027
Customer:	

DRW:	Jason	CHKD	Jules	MATL:	Wu	DATE	06.06.2009
APPD:	Join			FINISH	Shieh	Sheet	2 from 2