

# EDCON-COMPONENTS

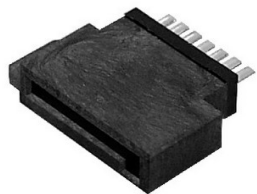

## Technical Discription

Temperature Range:	. -30°C ~ +70°C
Rated Load	DC30V 0,5A
Contact Resistance:	≤ 0,03 Ω
Insulation Resistance:	≥ 500M Ω
Withstanding Voltage:	AC 500V / 50Hz) 1 min.
Insertion and Extraction Force:	3 ~ 20N
Lifetime:	5000 cycles

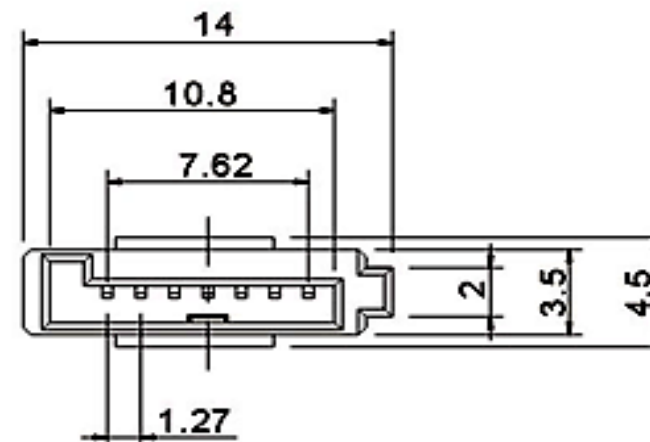
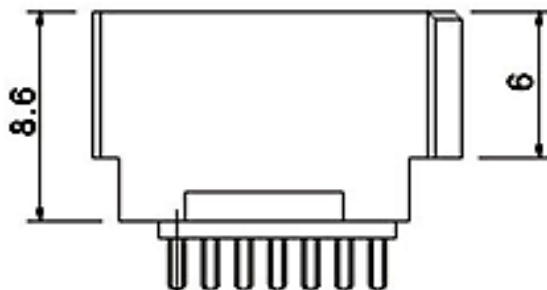
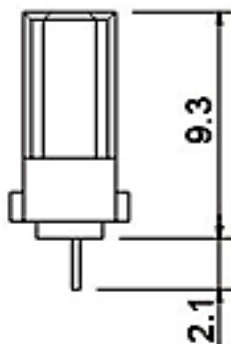

<b>SATA Connector</b>	
Part No.:	<b>T77001</b>
Customer:	

DRW:	Jason	CHKD	Wilson	MATL:	Wilson	TOLERANCE	Mason	DATE	10.04.2009
APPD:	Schumi			FINISH	Jamy		Sheet No.		1 from 3

# EDCON-COMPONENTS

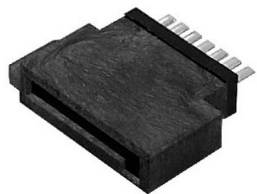

## Ordering Informations

Serie	Pos.	ROHS	Packing							
<b>T77001</b>	<b>07</b>	<b>R</b>	<b>TY</b>							

<b>07= 7Pos.</b>	<b>R= ROHS Conform</b>	<b>TY= Tray Package</b>
	<b>R= ROHS Conform</b>	<b>BU= Bulk Ware</b>

<b>SATA Connector</b>	
Part No.:	<b>T77001</b>
Customer:	

DRW:	Jason	CHKD	Wilson	MATL:	Wilson	TOLERANCE	Mason	DATE	10.04.2009
APPD:	Schumi			FINISH	Jamy		Sheet No.		2 from 3

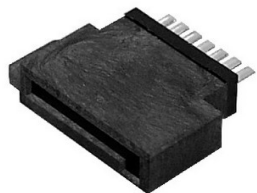

Lead Free Soldering Curve

Classification Reflow Profile (JEDEC J-STD-020C)

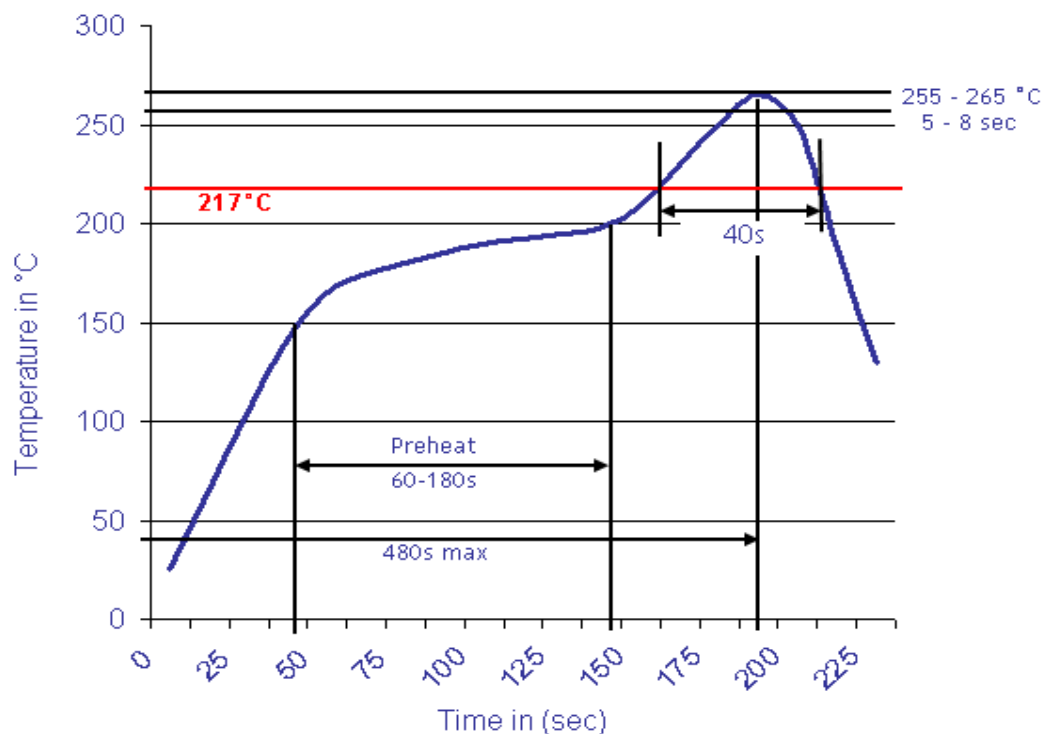

<b>SATA Connector</b>	
Part No.:	<b>T77001</b>
Customer:	

DRW:	Jason	CHKD	Wilson	MATL:	Wilson	TOLERANCE	Mason	DATE	10.04.2009
APPD:	Schumi			FINISH	Jamy		Sheet No.	3 from 3	