

EDCON-COMPONENTS



T65043

Technical Specifications:

Operating Temperature:	
Rated Load:	
Contact Resistance:	
Insulation Resistance:	
Withstanding Voltage:	
Actuating Force:	
Lifetime:	

. -40°C ~ 70°C
DC 30V / 0,2A
< 0,03 Ohm
> 100M Ohm
AC 500V (50Hz) 1min.
10 ~ 35N
5000 cycles

Technical Drawing:

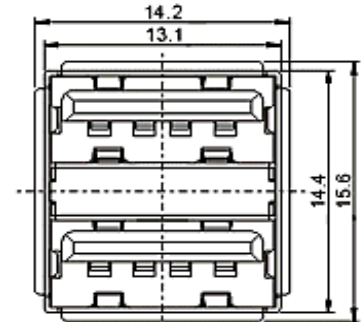
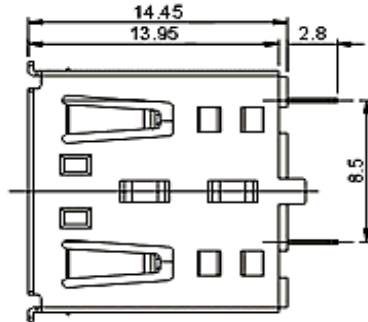
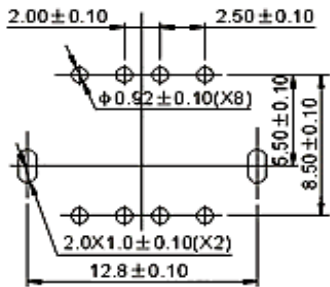

USB-A CONNECTOR	
Part No.:	T65043
Customer:	

DRW:	Jason	CHKD	Wilson	MATL:	Wilson	DATE	06.05.2007
APPD:	Schumi			FINISH	Jamy	Sheet	1 from 2

Copyright by EDCON-COMPONENTS H.Schmitt 11.6.2009

EDCON-COMPONENTS



Solder Profile

Lead Solder

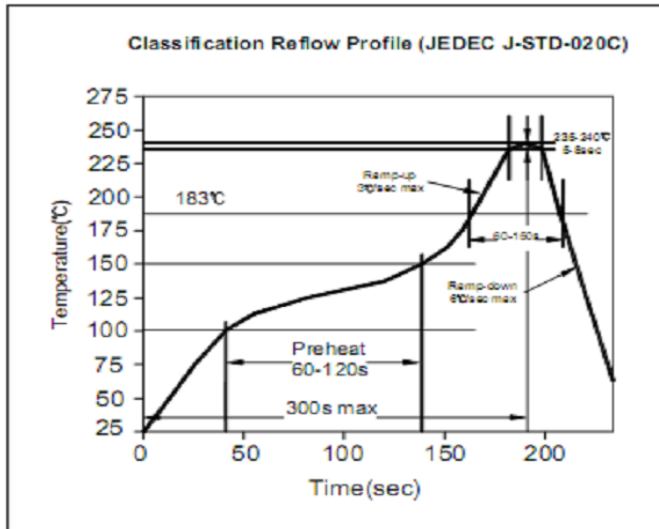

Lead free Solder

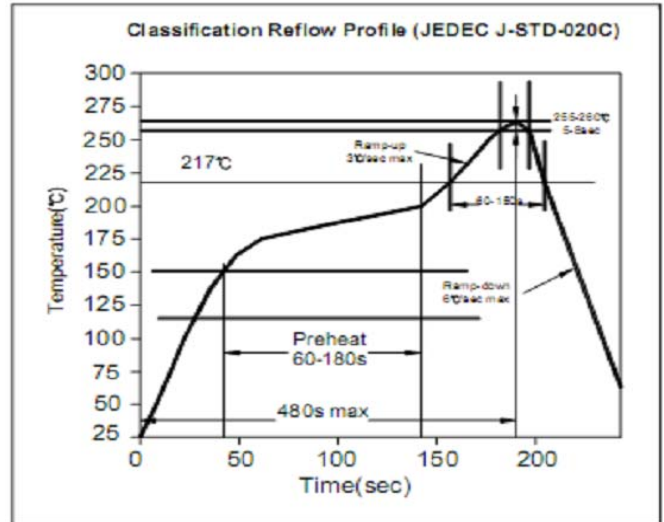

Ordering Informations:

Item-No.	ROHS	Packing				
----------	------	---------	--	--	--	--

T65043	R	BU				
--------	---	----	--	--	--	--

R= ROHS	BU= Bulk (Standard)	
N= Non ROHS	TY= Tray Packing	
	TU= Tube Packing	

USB-A CONNECTOR	
Part No.:	T65043
Customer:	

DRW:	Jason	CHKD	Wilson	MATL:	Wilson	DATE	06.05.2007
APPD:	Schumi			FINISH	Jamy	Sheet	2 from 2

Copyright by EDCON-COMPONENTS H.Schmitt 11.6.2009