

# EDCON-COMPONENTS



## Technical Discription

Temperature Range:	-40°C ~ + 70°C
Rated Load:	DC 50V/0,2A
Contact Resistance:	≤ 0,03 Ω
Insulation Resistance:	≥ 100M Ω
Withstanding Voltage:	AC 500V (50Hz) 1 min.
Insertion & Extraction Force:	3-25N
Lifetime:	5000 cycles

## Technical Drawing

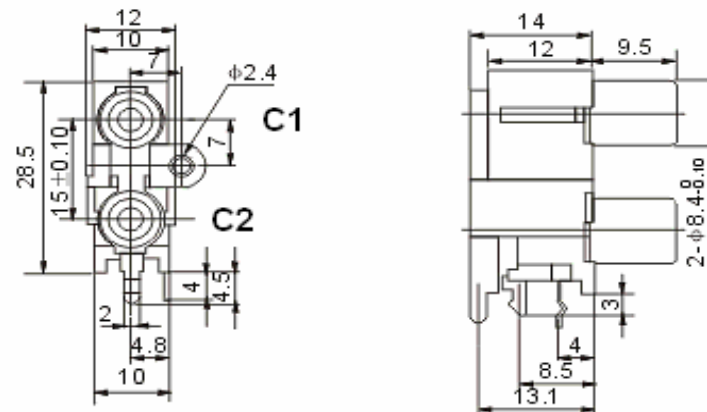

## PCB Layout

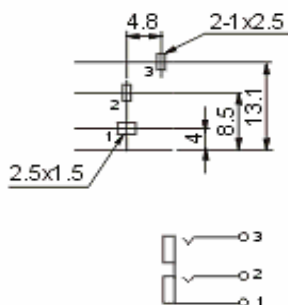

### RCA Connector

Part No.: **T53048**

Customer:

DRW:	Jason	CHKD	Wilson	MATL:	Wilson	TOLERANCE	Mason	DATE	15.08.2009
APPD:	Schumi			FINISH	Jamy		Sheet No.	1 from 3	

# EDCON-COMPONENTS



## Ordering Informations

Serie	C1-Color	C2-Color	Cont.Plating	ROHS	Package					
<b>T53048</b>	<b>RD</b>	<b>RD</b>	<b>T</b>	<b>R</b>	<b>BU</b>					

<b>RD= Red</b>	<b>RD= Red</b>	<b>T= Tin plated</b>	<b>R= ROHS Conform</b>	<b>BU= BULK-WARE</b>
<b>BL= Blue</b>	<b>BL= Blue</b>			
<b>YE= Yellow</b>	<b>YE= Yellow</b>	<b>G= Gold Flash plated MOQ on request</b>	<b>N= NON ROHS Conform</b>	<b>TY= TRAY Packing</b>
<b>GN= Green</b>	<b>GN= Green</b>			
<b>GY= Gray</b>	<b>GY= Gray</b>			

<b>RCA Connector</b>	
Part No.:	<b>T53048</b>
Customer:	

DRW:	Jason	CHKD	Wilson	MATL:	Wilson	TOLERANCE	Mason	DATE	15.08.2009
APPD:	Schumi			FINISH	Jamy		Sheet No.		2 from 3

[www.edcon-components.com](http://www.edcon-components.com)

email: [info@edcon-components.com](mailto:info@edcon-components.com)



Soldering Profile Curve

Classification Reflow Profile (JEDEC J-STD-020C)



<b>RCA Connector</b>	
Part No.:	<b>T53048</b>
Customer:	

DRW:	Jason	CHKD	Wilson	MATL:	Wilson	TOLERANCE	Mason	DATE	15.08.2009
APPD:	Schumi			FINISH	Jamy		Sheet No.	3 from 3	