

EDCON-COMPONENTS



Technical Discription

Temperature Range:	-40°C ~ + 70°C
Rated Load:	DC 50V/0,2A
Contact Resistance:	≤ 0,03 Ω
Insulation Resistance:	≥ 100M Ω
Withstanding Voltage:	AC 500V (50Hz) 1 min.
Insertion & Extraction Force:	3-25N
Lifetime:	5000 cycles

Technical Drawing

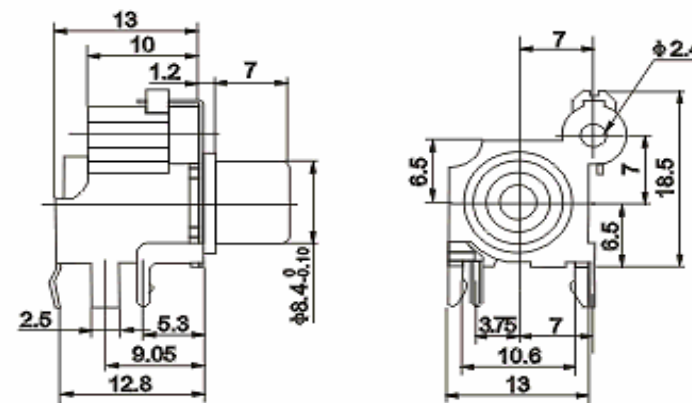

PCB Layout

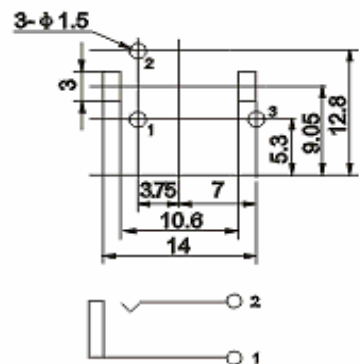

RCA Connector

Part No.: **T53014**

Customer:

DRW:	Jason	CHKD	Wilson	MATL:	Wilson	TOLERANCE	Mason	DATE	15.08.2009
APPD:	Schumi			FINISH	Jamy		Sheet No.		1 from 3

EDCON-COMPONENTS



Ordering Informations

Serie	Body-Color	Cont.-Color	Cont.Plating	ROHS	Package					
T53014	RD	RD	T	R	BU					

RD= Red	RD= Red	T= Tin plated	R= ROHS Conform	BU= BULK-WARE
BL= Blue	BL= Blue			
YE= Yellow	YE= Yellow	G= Gold Flash plated MOQ on request	N= NON ROHS Conform	TY= TRAY Packing
GN= Green	GN= Green			
GY= Gray	GY= Gray			

RCA Connector	
Part No.:	T53014
Customer:	

DRW:	Jason	CHKD	Wilson	MATL:	Wilson	TOLERANCE	Mason	DATE	15.08.2009
APPD:	Schumi			FINISH	Jamy		Sheet No.		2 from 3

www.edcon-components.com

email: info@edcon-components.com



Soldering Profile Curve

Classification Reflow Profile (JEDEC J-STD-020C)

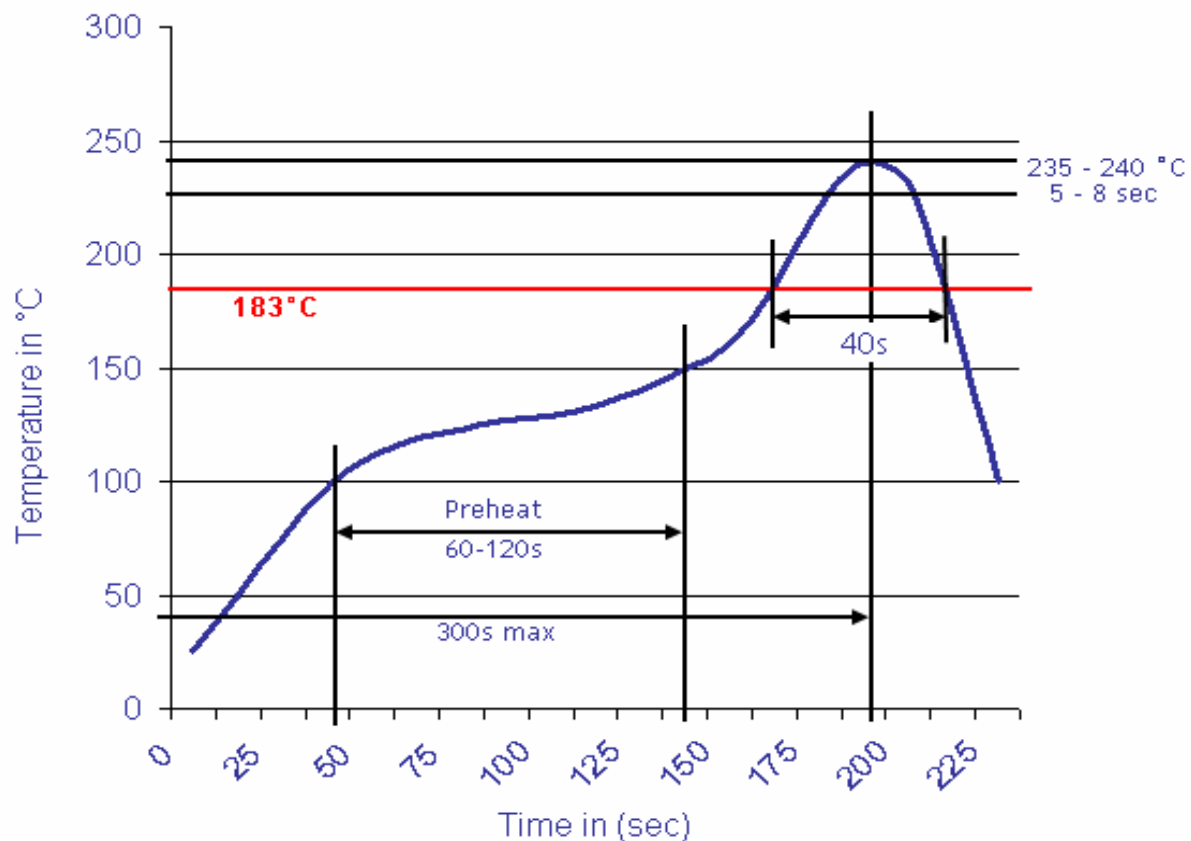

RCA Connector	
Part No.:	T53014
Customer:	

DRW:	Jason	CHKD	Wilson	MATL:	Wilson	TOLERANCE	Mason	DATE	15.08.2009
APPD:	Schumi			FINISH	Jamy		Sheet No.	3 from 3	