

EDCON-COMPONENTS

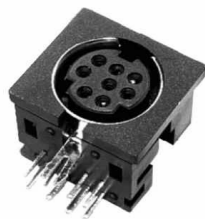

Technical Discription

Temperature Range:	-25°C ~ + 70°C
Rated Load:	DC 30V/0,5A
Contact Resistance:	≤ 0,03 Ω
Insulation Resistance:	≥ 100M Ω
Withstanding Voltage:	AC 250V (50Hz) 1 min.
Insertion & Extraction Force:	5-30N
Lifetime:	1000 cycles

Technical Drawing

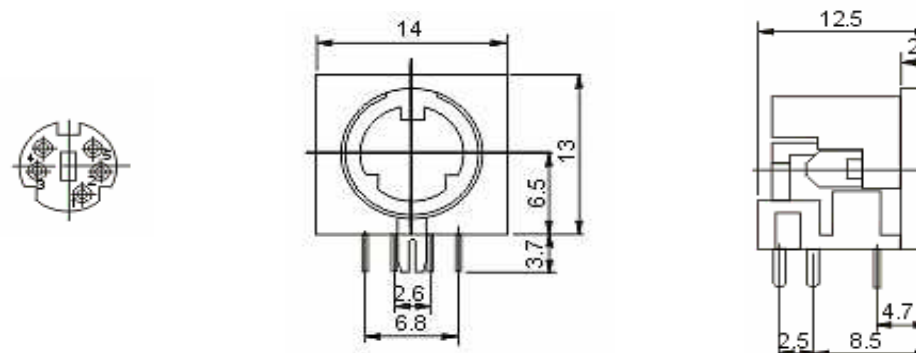

PCB Layout

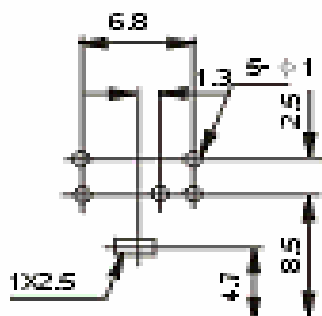

DIN Connector

Part No.: **T20H103**

Customer:

DRW:	Jason	CHKD	Wilson	MATL:	Wilson	TOLERANCE	Mason	DATE	12.05.2009
APPD:	Schumi			FINISH	Jamy		Sheet No.	1 from 3	

EDCON-COMPONENTS



Ordering Informations

Serie	Pos.	ROHS	Package							
T20H103	05	R	TY							

R= ROHS Conform	BU= BULK-WARE
N= NON ROHS Conform	TY= Tray Packing

DIN Connector
Part No.: T20H103
Customer:

DRW:	Jason	CHKD	Wilson	MATL:	Wilson	TOLERANCE	Mason	DATE	12.05.2009
APPD:	Schumi			FINISH	Jamy		Sheet No.	2 from 3	

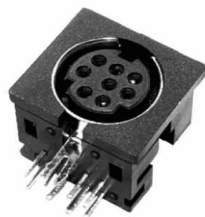

Soldering Profile Curve

Classification Reflow Profile (JEDEC J-STD-020C)



DIN Connector	
Part No.:	T20H103
Customer:	

DRW:	Jason	CHKD	Wilson	MATL:	Wilson	TOLERANCE	Mason	DATE	12.05.2009
APPD:	Schumi			FINISH	Jamy		Sheet No.	3 from 3	