

EDCON-COMPONENTS



Technical Discription

Temperature Range: . -25°C ~ + 70°C
 Rated Load: DC 30V/0,5A
 Contact Resistance: ≤ 0,03 Ω
 Insulation Resistance: ≥ 100M Ω
 Withstanding Voltage: AC 250V (50Hz) 1 min.
 Insertion & Extraction Force: 5-30N
 Lifetime: 1000 cycles

Technical Drawing

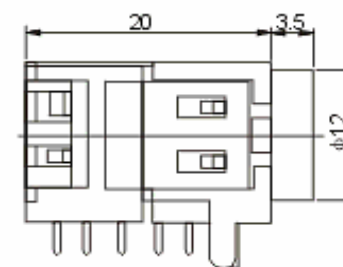
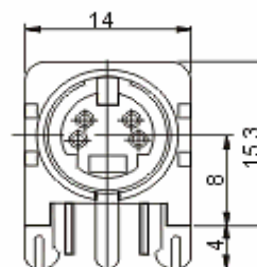

PCB Layout

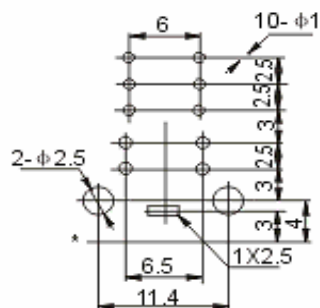

DIN Connector

Part No.: **T20H073**

Customer:

DRW:	Jason	CHKD	Wilson	MATL:	Wilson	TOLERANCE	Mason	DATE	12.05.2009
APPD:	Schumi			FINISH	Jamy		Sheet No.	1 from 3	

EDCON-COMPONENTS



Ordering Informations

Serie	Pos.	ROHS	Package							
T20H073	04	R	TY							

R= ROHS Conform	BU= BULK-WARE
N= NON ROHS Conform	TY= TRAY Packing

DIN Connector
Part No.: T20H073
Customer:

DRW:	Jason	CHKD	Wilson	MATL:	Wilson	TOLERANCE	Mason	DATE	12.05.2009
APPD:	Schumi			FINISH	Jamy		Sheet No.	2 from 3	



Soldering Profile Curve

Classification Reflow Profile (JEDEC J-STD-020C)



DIN Connector	
Part No.:	T20H073
Customer:	

DRW:	Jason	CHKD	Wilson	MATL:	Wilson	TOLERANCE	Mason	DATE	12.05.2009
APPD:	Schumi			FINISH	Jamy		Sheet No.	3 from 3	