

# EDCON-COMPONENTS



## Technical Discription

Temperature Range: . -25°C ~ + 70°C  
 Rated Load: DC 30V/0,5A  
 Contact Resistance: ≤ 0,03 Ω  
 Insulation Resistance: ≥ 100M Ω  
 Withstanding Voltage: AC 250V (50Hz) 1 min.  
 Insertion & Extraction Force: 5-30N  
 Lifetime: 1000 cycles

## Technical Drawing

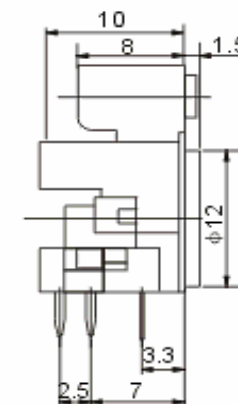
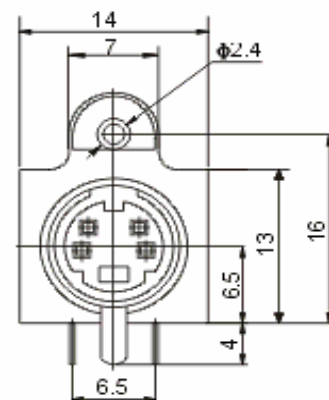

## PCB Layout

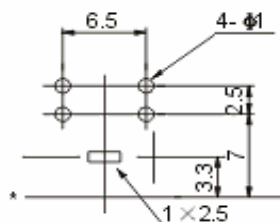

### Mini-DIN Connector

Part No.: **T20H039**

Customer:

DRW:	Jason	CHKD	Wilson	MATL:	Wilson	TOLERANCE	Mason	DATE	12.05.2009
APPD:	Schumi			FINISH	Jamy		Sheet No.	1 from 3	

# EDCON-COMPONENTS



## Ordering Informations

Serie	Pos.	ROHS	Package							
<b>T20H039</b>	<b>04</b>	<b>R</b>	<b>TY</b>							

<b>R=</b> ROHS Conform	<b>BU=</b> BULK-WARE
<b>N=</b> NON ROHS Conform	<b>TY=</b> TRAY Packing

<b>Mini-DIN Connector</b>
Part No.: <b>T20H039</b>
Customer:

DRW:	Jason	CHKD	Wilson	MATL:	Wilson	TOLERANCE	Mason	DATE	12.05.2009
APPD:	Schumi			FINISH	Jamy		Sheet No.	2 from 3	



**Soldering Profile Curve**

Classification Reflow Profile (JEDEC J-STD-020C)



**Mini-DIN Connector**

Part No.: **T20H039**

DRW:	Jason	CHKD	Wilson	MATL:	Wilson	TOLERANCE	Mason	DATE	12.05.2009
APPD:	Schumi			FINISH	Jamy		Sheet No.	3 from 3	Customer: