

EDCON-COMPONENTS



Technical Discription

Temperature Range:	-25°C ~ + 70°C
Rated Load:	DC 30V/0,5A
Contact Resistance:	≤ 0,03 Ω
Insulation Resistance:	≥ 100M Ω
Withstanding Voltage:	AC 250V (50Hz) 1 min.
Insertion & Extraction Force:	5-30N
Lifetime:	1000 cycles

Technical Drawing

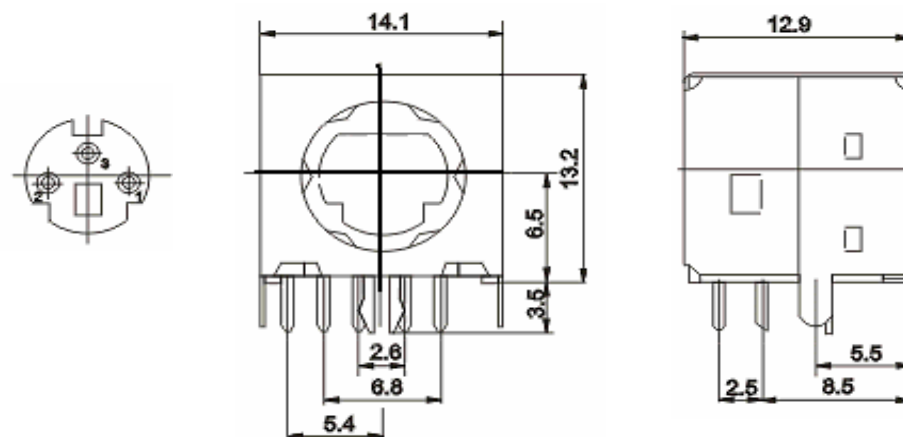

PCB Layout

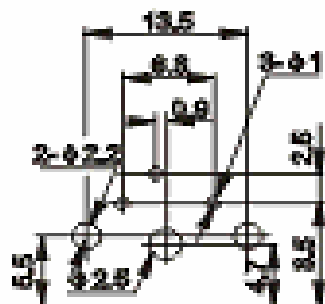

Mini-DIN Connector

Part No.: **T20H029**

Customer:

DRW:	Jason	CHKD	Wilson	MATL:	Wilson	TOLERANCE	Mason	DATE	12.05.2009
APPD:	Schumi			FINISH	Jamy		Sheet No.		1 from 3

EDCON-COMPONENTS



Ordering Informations

Serie	Pos.	ROHS	Package							
T20H029	03	R	TY							

R= ROHS Conform	BU= BULK-WARE
N= NON ROHS Conform	TY= TRAY Packing

Mini-DIN Connector

Part No.: **T20H029**

Customer:

DRW:	Jason	CHKD	Wilson	MATL:	Wilson	TOLERANCE	Mason	DATE	12.05.2009
APPD:	Schumi			FINISH	Jamy		Sheet No.		2 from 3



Soldering Profile Curve

Classification Reflow Profile (JEDEC J-STD-020C)



Mini-DIN Connector

Part No.: **T20H029**

DRW:	Jason	CHKD	Wilson	MATL:	Wilson	TOLERANCE	Mason	DATE	12.05.2009
APPD:	Schumi			FINISH	Jamy		Sheet No.	3 from 3	Customer: