

# EDCON-COMPONENTS



## Technical Discription

Temperature Range:	-25°C ~ + 70°C
Rated Load:	DC 30V/0,5A
Contact Resistance:	≤ 0,03 Ω
Insulation Resistance:	≥ 100M Ω
Withstanding Voltage:	AC 250V (50Hz) 1 min.
Insertion & Extraction Force:	5-30N
Lifetime:	1000 cycles

## Technical Drawing

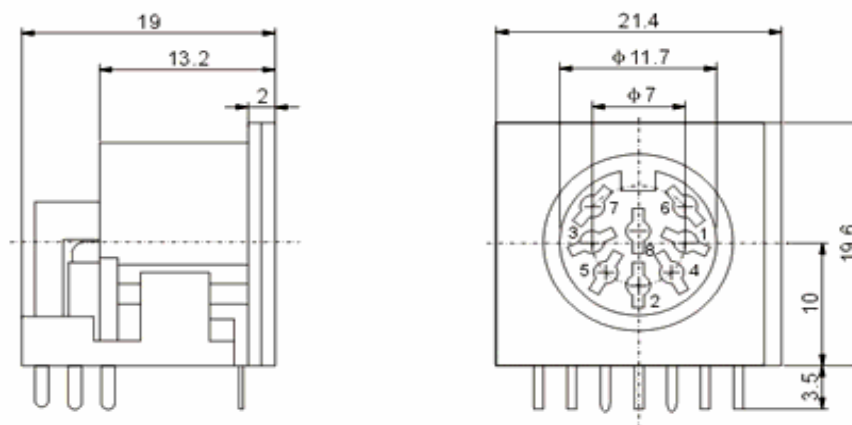

## PCB Layout

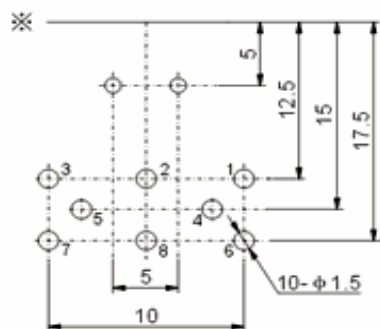

### DIN Connector

Part No.: **T20B028**

Customer:

DRW:	Jason	CHKD	Wilson	MATL:	Wilson	TOLERANCE	Mason	DATE	12.05.2009
APPD:	Schumi			FINISH	Jamy		Sheet No.	1 from 3	

# EDCON-COMPONENTS



## Ordering Informations

Serie	Pos.	ROHS	Package							
<b>T20B028</b>	<b>08</b>	<b>R</b>	<b>TY</b>							

<b>R=</b> ROHS Conform	<b>BU=</b> BULK-WARE
<b>N=</b> NON ROHS Conform	<b>TY=</b> TRAY Packing

<b>DIN Connector</b>
Part No.: <b>T20B028</b>
Customer:

DRW:	Jason	CHKD	Wilson	MATL:	Wilson	TOLERANCE	Mason	DATE	12.05.2009
APPD:	Schumi			FINISH	Jamy		Sheet No.	2 from 3	



**Soldering Profile Curve**

Classification Reflow Profile (JEDEC J-STD-020C)



<b>DIN Connector</b>	
Part No.:	<b>T20B028</b>
Customer:	

DRW:	Jason	CHKD	Wilson	MATL:	Wilson	TOLERANCE	Mason	DATE	12.05.2009
APPD:	Schumi			FINISH	Jamy		Sheet No.	3 from 3	