

EDCON-COMPONENTS



Technical Specifications:

Temperature Range:	DC 30V 0,5A
Rated Load:	3~20n
Contact Resistance:	0,5KG ~ 3,5KG
Insulation Resistance:	
Withstanding Voltage:	500 VOLTS
Actuating Force:	
Lifetime:	5000 cycles
TEMPERATURE:	FROM -30°C TO +70°C
RELATIVE HUMIDITY:	FROM 40% TO 85%
HUMIDITY TEST:	HUMIDITY 90% TO 95% TEMPERATURE 40°C +/- 2°C F. 96 HRS
HEAT TEST:	TEMPERATURE 70°C +/- 2°C V (HUMIDITY BELOW 50% F. 96HRS
COLD TEST:	. +/-2°C FOR 96 HOURS
SOLDERABILITY TEST:	THE TERMINATION IS AT LEAST 96% COVERD BY A CONTINUOUS NEW SOLDER COATING
TEST CONDITIONS:	DIP SOLDER FOR 5 SEC AT 245°C +/- 5°C TERMINATION SHAL BE IMMERSIED IN FLUX BEFORE TEST
REFLOW SOLDERING:	LEAD FREE PROCESS
MATERIAL:	STAINLESS 0,1T
F= GROUNDING SPRING	BRASS STRIP 0,3T NI 60μ
E= SHIELDING:	BRASS BAR NI 60μ
D= PIN	BRASS STRIP 0,3T AG 20μ OVER NI 20μ
C=TERMINAL	COPPER ALLOY 0,3T AG20μ OVER NI 20μ
B= TIP SPRING	HIGH TEMPERATURE THERMOPLASTIC UL 94V-0 BLACK
A= BODY	

THT DC-POWER JACK	
Part No.:	T19B081
Customer:	

DRW:	Jason	CHKD	Wilson	MATL:	Wilson	DATE	06.05.2007
APPD:	Schumi			FINISH	Jamy	Sheet	1 from 3

EDCON-COMPONENTS



Technical Drawing:

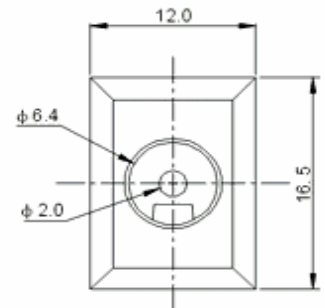
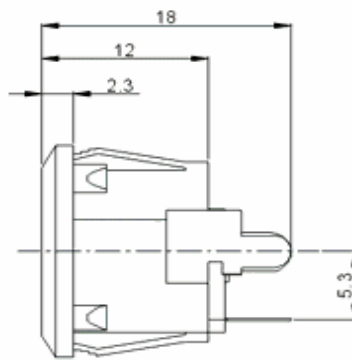
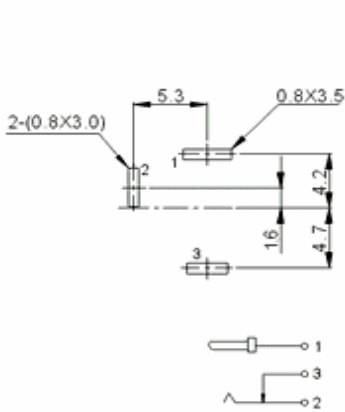

THT DC-POWER JACK	
Part No.:	T19B081
Customer:	

DRW:	Jason	CHKD	Wilson	MATL:	Wilson	DATE	06.05.2007
APPD:	Schumi			FINISH	Jamy	Sheet	2 from 3

EDCON-COMPONENTS



Solder Profile

Lead Solder



Lead Free Solder



Ordering Informations:

Item-No.	Pin Diameter	ROHS	Packing			
----------	--------------	------	---------	--	--	--

T19B081	A	R	BU			
----------------	----------	----------	-----------	--	--	--

A= 2,0mm	R= ROHS	BU= Bulk (Standard)
	N= Non ROHS	TR= Tape/Reel
		TR= Tray Packing

THT DC-POWER JACK	
Part No.:	T19B081
Customer:	

DRW:	Jason	CHKD	Wilson	MATL:	Wilson		06.05.2007
APPD:	Schumi			FINISH	Jamy	Sheet	3 from 3