

EDCON-COMPONENTS



Technical Specifications:

Temperature Range:
Rated Load:
Contact Resistance:
Insulation Resistance:
Withstanding Voltage:
Actuating Force:
Lifetime:
TEMPERATURE:
RELATIVE HUMIDITY:
HUMIDITY TEST:
HEAT TEST:
COLD TEST:
SOLDERABILITY TEST:
TEST CONDITIONS:
REFLOW SOLDERING:
MATERIAL:
F= GROUNDING SPRING
E= SHIELDING:
D= PIN
C=TERMINAL
B= TIP SPRING
A= BODY

DC 30V 0,5A
3~20n
0,5KG ~ 3,5KG
500 VOLTS
5000 cycles
FROM -30°C TO +70°C
FROM 40% TO 85%
HUMIDITY 90% TO 95% TEMPERATURE 40°C +/- 2°C F. 96 HRS
TEMPERATURE 70°C +/- 2°C V (HUMIDITY BELOW 50% F. 96HRS
. +/-2°C FOR 96 HOURS
THE TERMINATION IS AT LEAST 96% COVERD BY A CONTINUOUS NEW SOLDER COATING
DIP SOLDER FOR 5 SEC AT 245°C +/- 5°C TERMINATION SHAL BE IMMERSIED IN FLUX BEFORE TEST
LEAD FREE PROCESS

STAINLESS 0,1T
BRASS STRIP 0,3T NI 60μ
BRASS BAR NI 60μ
BRASS STRIP 0,3T AG 20μ OVER NI 20μ
COPPER ALLOY 0,3T AG20μ OVER NI 20μ
HIGH TEMPERATURE THERMOPLASTIC UL 94V-0 BLACK

THT DC-POWER JACK	
Part No.:	T19B049
Customer:	

DRW:	Jason	CHKD	Wilson	MATL:	Wilson	DATE	06.05.2007
APPD:	Schumi			FINISH	Jamy	Sheet	1 from 3

EDCON-COMPONENTS



Technical Drawing:

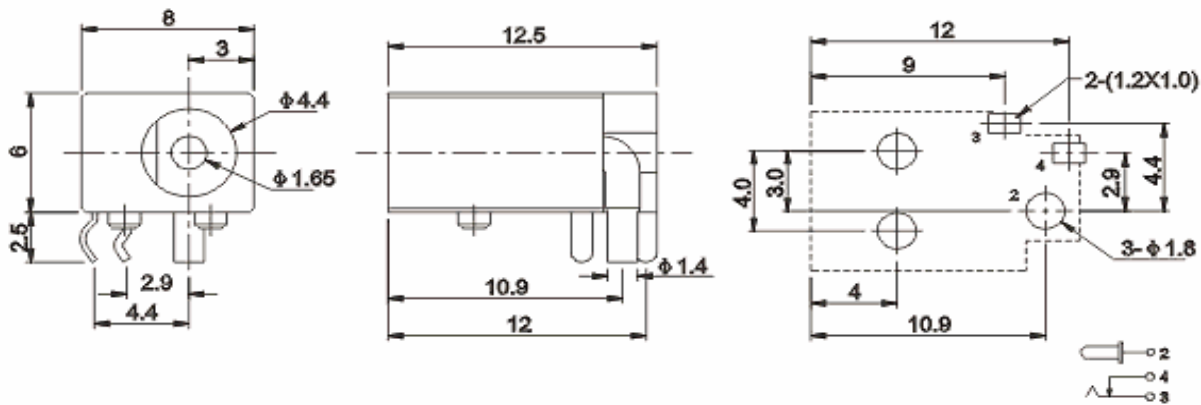

THT DC-POWER JACK	
Part No.:	T19B049
Customer:	

DRW:	Jason	CHKD	Wilson	MATL:	Wilson	DATE	06.05.2007
APPD:	Schumi			FINISH	Jamy	Sheet	2 from 3

EDCON-COMPONENTS



Solder Profile

Lead Solder



Lead Free Solder

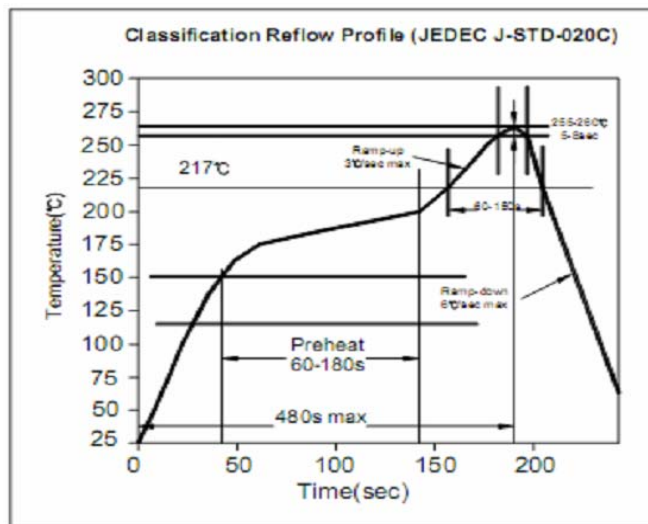

Ordering Informations:

Item-No.	Pin Diameter	ROHS	Packing			
----------	--------------	------	---------	--	--	--

T19B049	A	R	BU			
----------------	----------	----------	-----------	--	--	--

A= 1,65mm	R= ROHS	BU= Bulk (Standard)
	N= Non ROHS	TR= Tape/Reel
		TR= Tray Packing

THT DC-POWER JACK	
Part No.:	T19B049
Customer:	

DRW:	Jason	CHKD	Wilson	MATL:	Wilson		06.05.2007
APPD:	Schumi			FINISH	Jamy	Sheet	3 from 3