

# EDCON-COMPONENTS

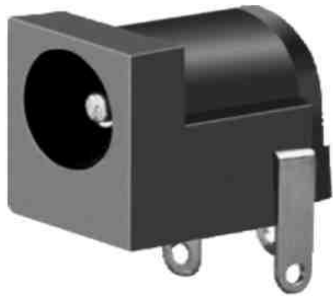

## Technical Specifications:

Temperature Range:	125VAC RMS / 1,5A / 30VDC/4,0A
Rated Load:	3~20n
Contact Resistance:	0,5KG ~ 3,5KG
Insulation Resistance:	
Withstanding Voltage:	500 VOLTS
Actuating Force:	
Lifetime:	5000 cycles
TEMPERATURE:	FROM -30°C TO +70°C
RELATIVE HUMIDITY:	FROM 40% TO 85%
HUMIDITY TEST:	HUMIDITY 90% TO 95% TEMPERATURE 40°C +/- 2°C F. 96 HRS
HEAT TEST:	TEMPERATURE 70°C +/- 2°C CV (HUMIDITY BELOW 50% F. 96HRS
COLD TEST:	. +/-2°C FOR 96 HOURS
SOLDERABILITY TEST:	THE TERMINATION IS AT LEAST 96% COVERD BY A CONTINUOUS NEW SOLDER COATING
TEST CONDITIONS:	DIP SOLDER FOR 5 SEC AT 245°C +/- 5°C TERMINATION SHAL BE IMMERSIED IN FLUX BEFORE TEST
REFLOW SOLDERING:	LEAD FREE PROCESS
MATERIAL:	STAINLESS 0,1T
F= GROUNDING SPRING	BRASS STRIP 0,3T NI 60μ
E= SHIELDING:	BRASS BAR NI 60μ
D= PIN	BRASS STRIP 0,3T AG 20μ OVER NI 20μ
C=TERMINAL	COPPER ALLOY 0,3T AG20μ OVER NI 20μ
B= TIP SPRING	HIGH TEMPERATURE THERMOPLASTIC UL 94V-0 BLACK
A= BODY	

THT DC-POWER JACK

Part No.: **T19B010**

Customer:

DRW:	Jason	CHKD	Wilson	MATL:	Wilson	DATE	18.12.2017
APPD:	Schumi			FINISH	Jamy	Sheet	1 from 3

# EDCON-COMPONENTS

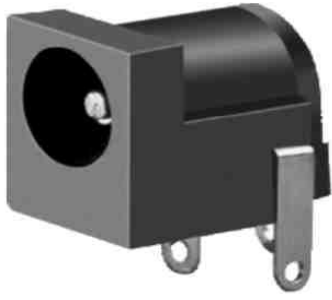

## Technical Drawing:

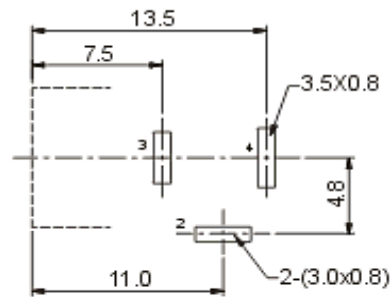
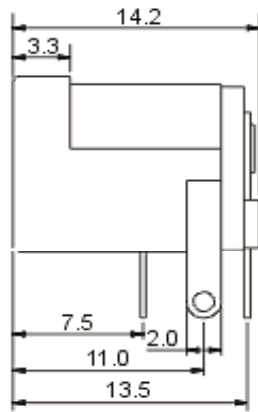
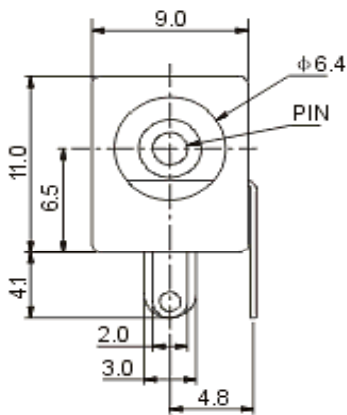

PIN	$\phi 1.65$	$\phi 2.0$	$\phi 2.35$	$\phi 2.5$	
APPD					

THT DC-POWER JACK	
Part No.:	<b>T19B010</b>
Customer:	

DRW:	Jason	CHKD	Wilson	MATL:	Wilson	DATE	18.12.2017
APPD:	Schumi			FINISH	Jamy	Sheet	2 from 3

# EDCON-COMPONENTS

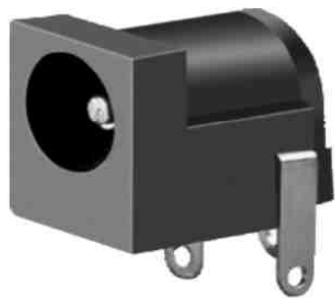

## Solder Profile

### Lead Solder

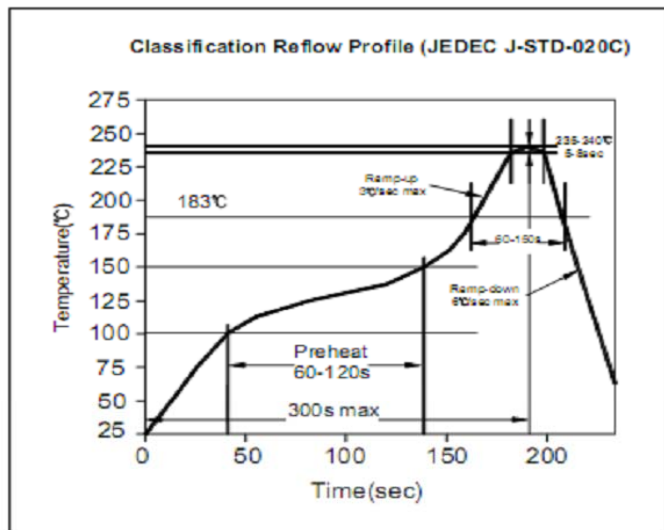

### Lead Free Solder

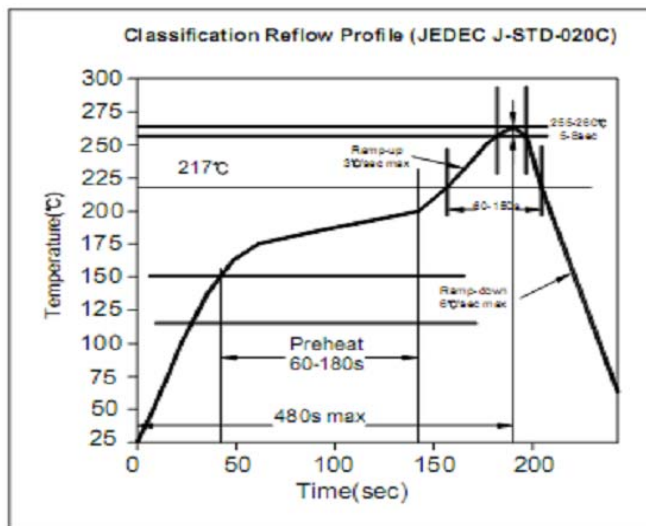

### Ordering Informations:

Item-No.	Pin Diameter	ROHS	Packing			
T19B010	A	R	BU			

A= 2,0mm	R= ROHS	BU= Bulk (Standard)
B= 2,35mm	N= Non ROHS	
C= 2,5mm		
D= 1,65mm		

THT DC-POWER JACK	
Part No.:	<b>T19B010</b>
Customer:	

DRW:	Jason	CHKD	Wilson	MATL:	Wilson	DATE	18.12.2017
APPD:	Schumi			FINISH	Jamy	Sheet	3 from 3

