

EDCON-COMPONENTS



T13P015

Technical Specifications:

Operating Temperature:	
Rated Load:	
Contact Resistance:	
Insulation Resistance:	
Withstanding Voltage:	
Actuating Force:	
Lifetime:	

. -20°C ~ + 70°C
DC50V / 1,0A
< 0,03 Ohm
> 100M Ohm
AC 500V (50Hz) 1min.
5 ~ 35N
10000 cycles

Technical Drawing:

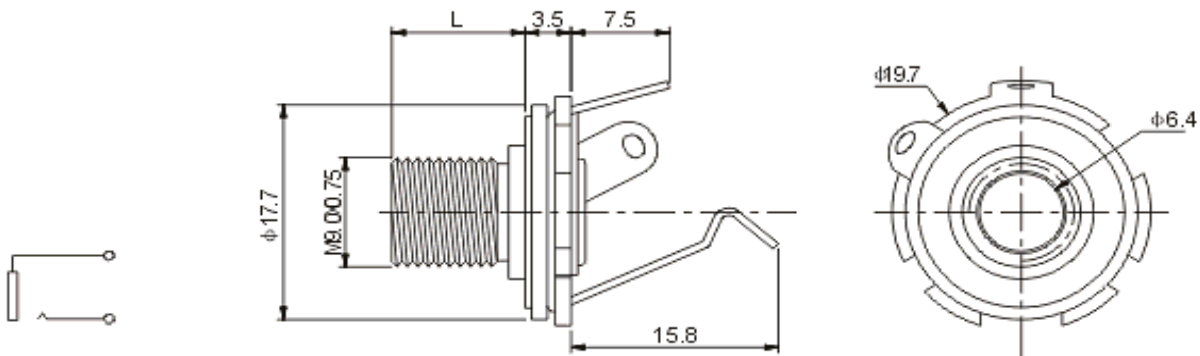

6,3mm THT Audio jack	
Part No.:	T13P015
Customer:	

DRW:	Jason	CHKD	Wilson	MATL:	Wilson	DATE	06.05.2007
APPD:	Schumi			FINISH	Jamy	Sheet	1 from 2

Copyright by EDCON-COMPONENTS H.Schmitt 11.6.2009

EDCON-COMPONENTS



Reel Specifications

Solder Profile

Lead Solder

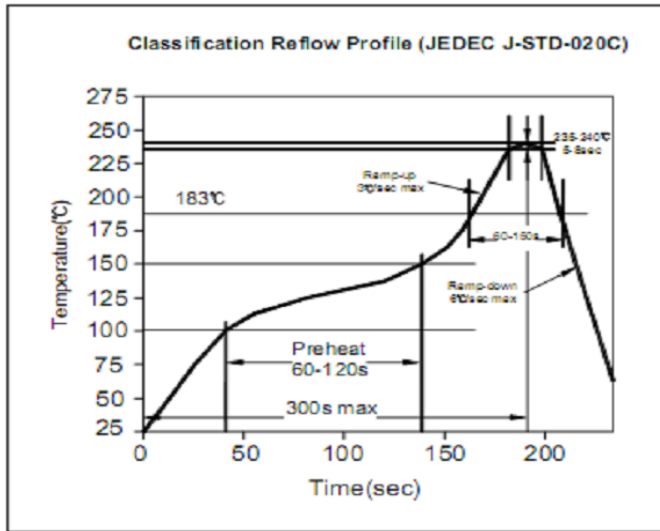

Lead free Solder



Ordering Informations:

Item-No.	Circuit	ROHS	Packing			
T13P015	A	R	BU			

A	R= ROHS	BU= Bulk (Standard)
	N= Non ROHS	
		TR= Tape/Reel
		TR= Tray Packing

6,3mm THT Audio jack	
Part No.:	T13P015
Customer:	

DRW:	Jason	CHKD	Wilson	MATL:	Wilson		06.05.2007
APPD:	Schumi			FINISH	Jamy	Sheet	2 from 2

Copyright by EDCON-COMPONENTS H.Schmitt 11.6.2009