

EDCON-COMPONENTS



Technical Discription

Temperature Range:	-20°C ~ + 70°C
Rated Load:	DC 50V/1A
Contact Resistance:	≤ 0,03 Ω
Insulation Resistance:	≥ 1000M Ω
Withstanding Voltage:	AC 500V (50Hz) 1 min.
Insertion & Extraction Force:	5-35N
Lifetime:	10000 cycles

Technical Dimensions

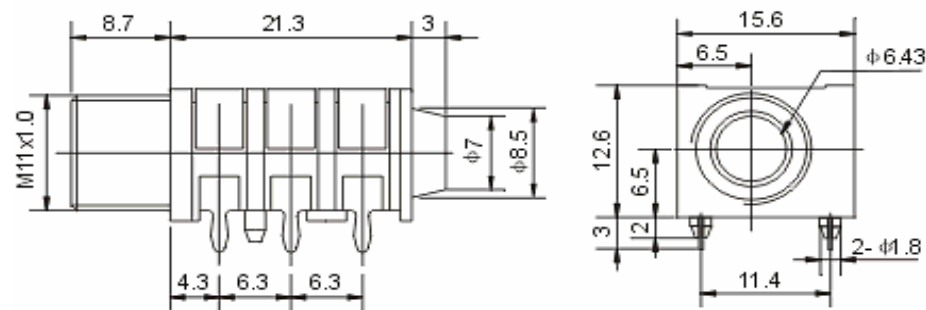

PCB Layout

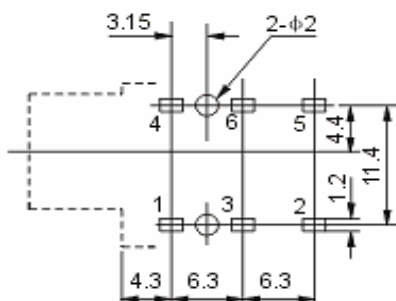

AUDIO 6,35mm Connector

Part No.: **T13L044**

Customer:

DRW:	Jason	CHKD	Wilson	MATL:	Wilson	TOLERANCE	Mason	DATE	10.04.2009
APPD:	Schumi			FINISH	Jamy		Sheet No.		1 from 3

EDCON-COMPONENTS



Circuit Code

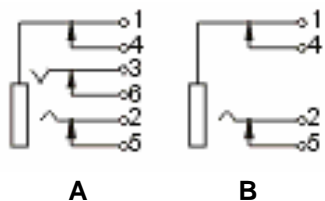

Ordering Informations

Serie	Circuit Code	ROHS	Packing							
T13L044	xx	R	BU							

XX= Look at Circuit Code	R= ROHS Conform	BU= BULK- WARE
	N= NON ROHS Conform	TY= TRAY Packing

AUDIO 6,35mm Connector
Part No.: T13L044
Customer:

DRW:	Jason	CHKD	Wilson	MATL:	Wilson	TOLERANCE	Mason	DATE	10.04.2009
APPD:	Schumi			FINISH	Jamy		Sheet No.		2 from 3

www.edcon-components.com

email: info@edcon-components.com



Soldering Profile Lead Free Curve

Classification Reflow Profile (JEDEC J-STD-020C)

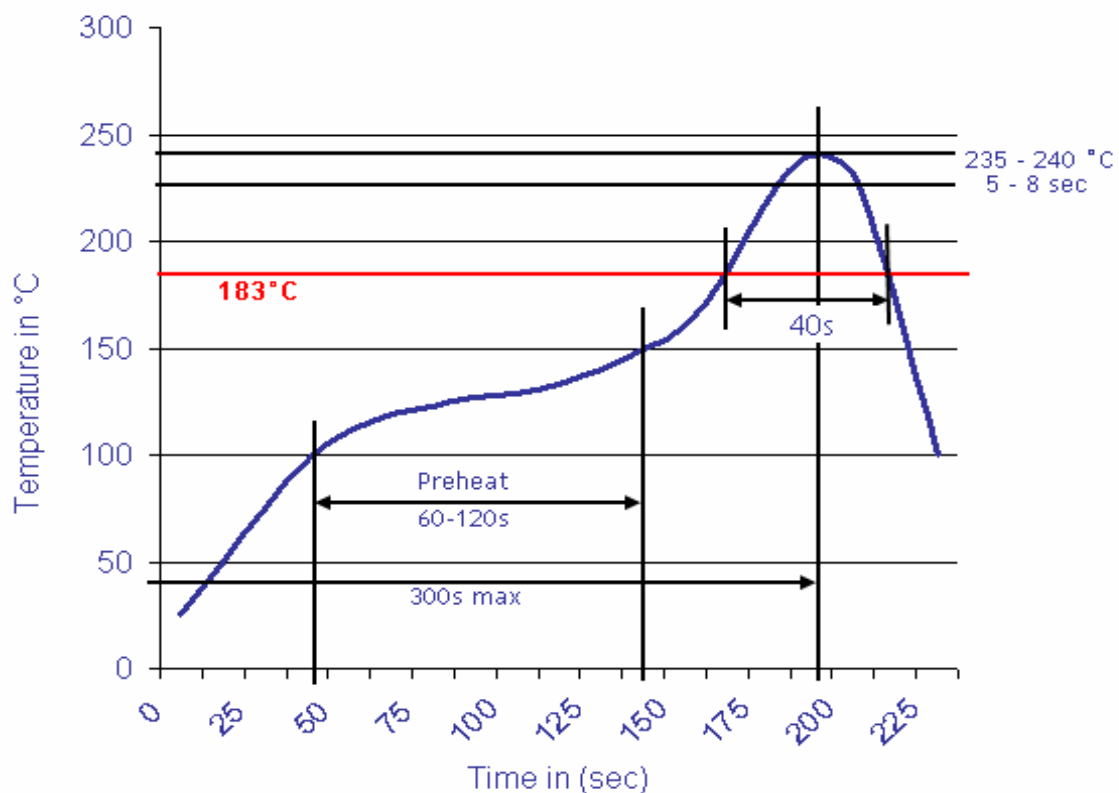

AUDIO 6,35mm Connector

Part No.: **T13L044**

DRW:	Jason	CHKD	Wilson	MATL:	Wilson	TOLERANCE	Mason	DATE	10.04.2009
APPD:	Schumi			FINISH	Jamy		Sheet No.	3 from 3	

Customer: