

# EDCON-COMPONENTS



## T13G156

### Technical Specifications:

Operating Temperature:	
Rated Load:	
Contact Resistance:	
Insulation Resistance:	
Withstanding Voltage:	
Actuating Force:	
Lifetime:	

. -30°C ~ + 70°C
DC 30V / 0,5A
< 0,03 Ohm
> 100M Ohm
AC 500V (50Hz) 1min.
3 ~ 20N
5000 cycles

### Technical Drawing:

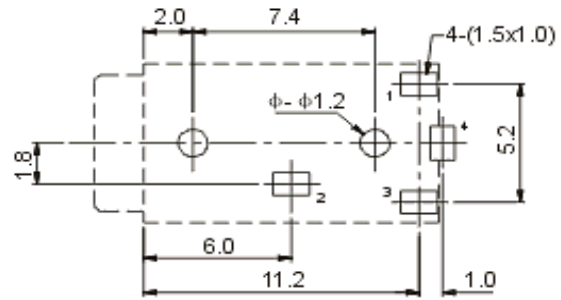
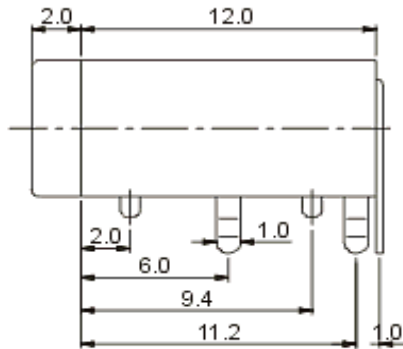
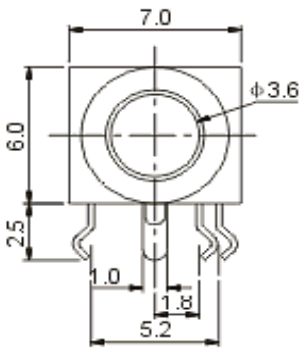

3,5mm THT Audio jack	
Part No.:	<b>T13G156</b>
Customer:	

DRW:	Jason	CHKD	Wilson	MATL:	Wilson	DATE	06.05.2007
APPD:	Schumi			FINISH	Jamy	Sheet	1 from 2

Copyright by EDCON-COMPONENTS H.Schmitt 11.6.2009

# EDCON-COMPONENTS



## Solder Profile

### Lead Solder

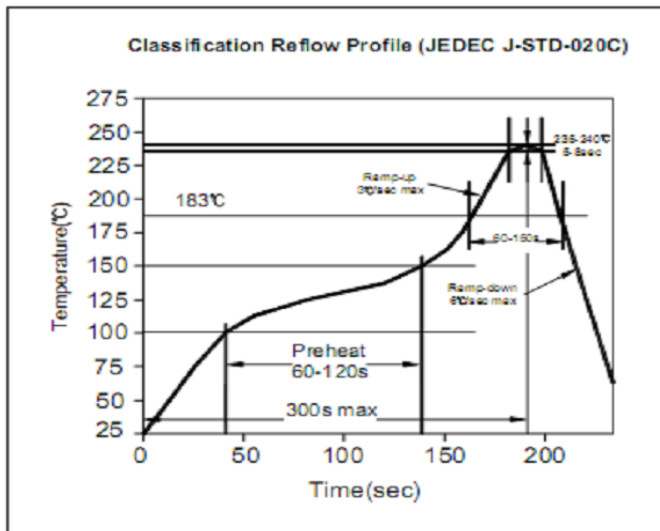

### Lead free Solder

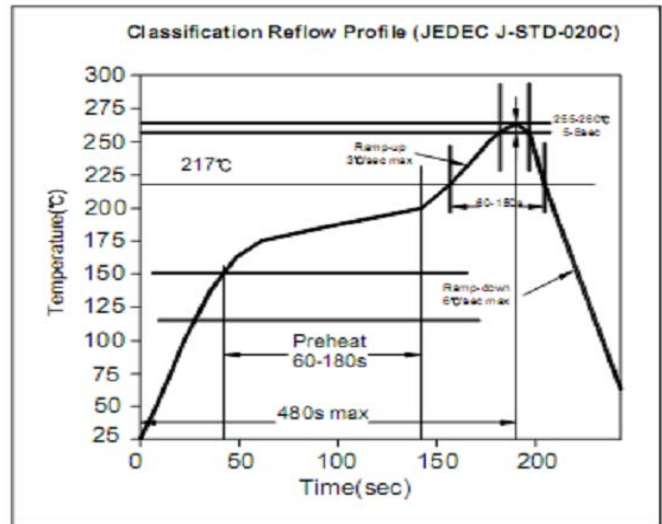

## Ordering Informations:

Item-No.	Circuit	ROHS	Packing			
<b>T13G156</b>	<b>A</b>	<b>R</b>	<b>BU</b>			

<b>A</b>	<b>R= ROHS</b>	<b>BU= Bulk (Standard)</b>
<b>B</b>	<b>N= Non ROHS</b>	
		<b>TY= Tray Packing</b>

3,5mm THT Audio jack
Part No.: <b>T13G156</b>
Customer:

DRW:	Jason	CHKD	Wilson	MATL:	Wilson	DATE	06.05.2007
APPD:	Schumi			FINISH	Jamy	Sheet	2 from 2

Copyright by EDCON-COMPONENTS H.Schmitt 11.6.2009