

EDCON-COMPONENTS

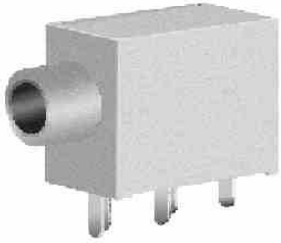

T13G098

Technical Specifications:

Operating Temperature:
Rated Load:
Contact Resistance:
Insulation Resistance:
Withstanding Voltage:
Actuating Force:
Lifetime:

. -30°C ~ + 70°C
DC 30V / 0,5A
< 0,03 Ohm
> 100M Ohm
AC 500V (50Hz) 1min.
3 ~ 20N
5000 cycles

Technical Drawing:

CK3.5-025	CK3.5-025-1	CK3.5-025-2	CK3.5-025-3
CK3.5-025M	CK3.5-025M-1	CK3.5-025M-2	CK3.5-025M-3
CK3.5-025GM	CK3.5-025GM-1	CK3.5-025GM-2	CK3.5-025GM-3
CK3.5-025B	CK3.5-025B-1	CK3.5-025B-2	CK3.5-025B-3
CK3.5-025C	CK3.5-025C-1	CK3.5-025C-2	CK3.5-025C-3
CK3.5-025D	CK3.5-025D-1	CK3.5-025D-2	CK3.5-025D-3

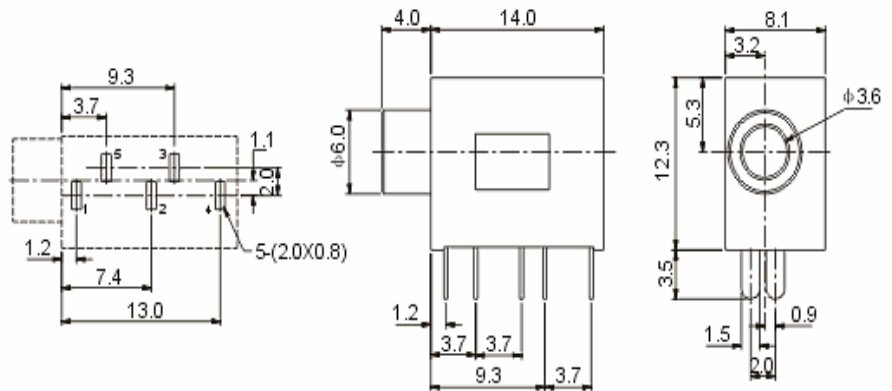

3,5mm THT Audio jack	
Part No.:	T13G098
Customer:	

DRW:	Jason	CHKD	Wilson	MATL:	Wilson	DATE	06.05.2007
APPD:	Schumi			FINISH	Jamy	Sheet	1 from 2

Copyright by EDCON-COMPONENTS H.Schmitt 11.6.2009

EDCON-COMPONENTS

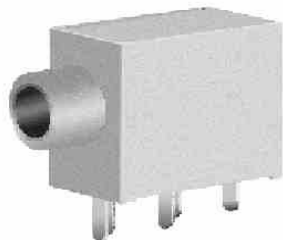

Solder Profile

Lead Solder



Lead free Solder



Ordering Informations:

Item-No.	Circuit	ROHS	Packing			
T13G098	A	R	BU			

A	R= ROHS	BU= Bulk (Standard) TY= Tray Packing
B	N= Non	
C	ROHS	
D		

3,5mm THT Audio jack	
Part No.:	T13G098
Customer:	

DRW:	Jason	CHKD	Wilson	MATL:	Wilson	DATE	06.05.2007
APPD:	Schumi			FINISH	Jamy	Sheet	2 from 2

Copyright by EDCON-COMPONENTS H.Schmitt 11.6.2009