

EDCON-COMPONENTS



T13G016

Technical Specifications:

| | |
|------------------------|--|
| Operating Temperature: | |
| Rated Load: | |
| Contact Resistance: | |
| Insulation Resistance: | |
| Withstanding Voltage: | |
| Actuating Force: | |
| Lifetime: | |
| | |
| | |

| |
|----------------------|
| . -30°C ~ + 70°C |
| DC 30V / 0,5A |
| < 0,03 Ohm |
| > 100M Ohm |
| AC 500V (50Hz) 1min. |
| 3 ~ 20N |
| 5000 cycles |
| |
| |

Technical Drawing:

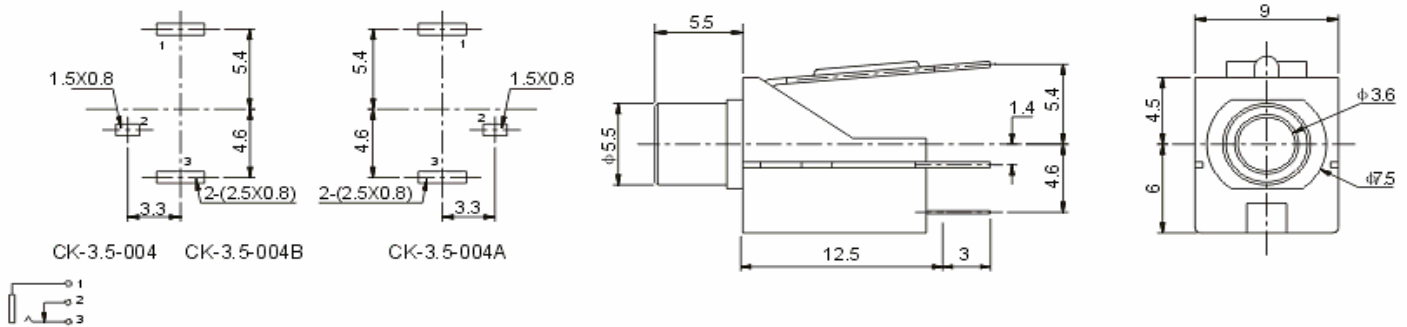

| | |
|----------------------|----------------|
| 3,5mm THT Audio jack | |
| Part No.: | T13G016 |
| Customer: | |

| | | | | | | | |
|-------|--------|------|--------|--------|--------|-------|------------|
| DRW: | Jason | CHKD | Wilson | MATL: | Wilson | DATE | 06.05.2007 |
| APPD: | Schumi | | | FINISH | Jamy | Sheet | 1 from 2 |

Copyright by EDCON-COMPONENTS H.Schmitt 11.6.2009

EDCON-COMPONENTS



Solder Profile

Lead Solder

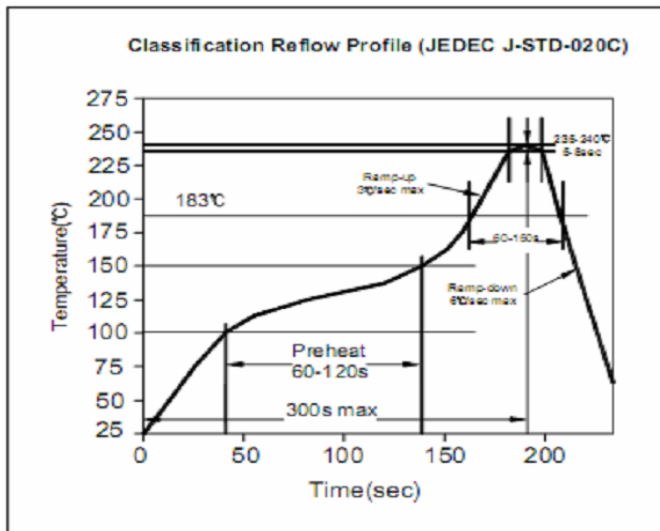

Lead free Solder

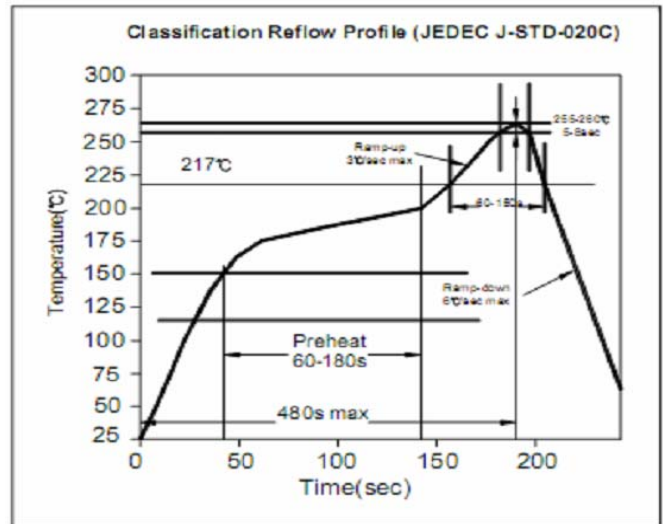

Ordering Informations:

| | | | | | | |
|----------------|----------|----------|-----------|--|--|--|
| Item-No. | Circuit | ROHS | Packing | | | |
| T13G016 | A | R | BU | | | |

| | | |
|----------|--------------------|----------------------------|
| A | R= ROHS | BU= Bulk (Standard) |
| | N= Non ROHS | |
| | | TY= Tray Packing |
| | | |
| | | |
| | | |

| |
|--------------------------|
| 3,5mm THT Audio jack |
| Part No.: T13G016 |
| Customer: |

| | | | | | | | |
|-------|--------|------|--------|--------|--------|-------|------------|
| DRW: | Jason | CHKD | Wilson | MATL: | Wilson | DATE | 06.05.2007 |
| APPD: | Schumi | | | FINISH | Jamy | Sheet | 2 from 2 |

Copyright by EDCON-COMPONENTS H.Schmitt 11.6.2009