

# EDCON-COMPONENTS

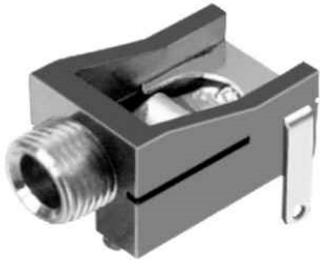

## T13G007

### Technical Specifications:

Operating Temperature:	
Rated Load:	
Contact Resistance:	
Insulation Resistance:	
Withstanding Voltage:	
Actuating Force:	
Lifetime:	

. -30°C ~ + 70°C
DC 30V / 0,5A
< 0,03 Ohm
> 100M Ohm
AC 500V (50Hz) 1min.
3 ~ 20N
5000 cycles

### Technical Drawing:

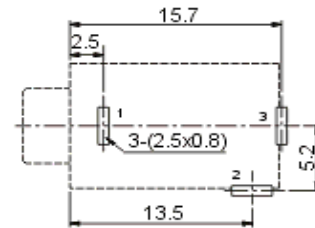
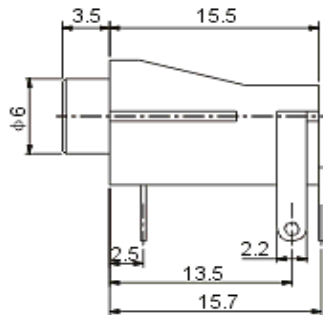
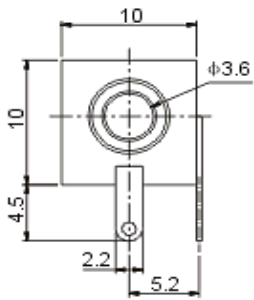

3,5mm THT Audio jack	
Part No.:	<b>T13G007</b>
Customer:	

DRW:	Jason	CHKD	Wilson	MATL:	Wilson	DATE	05.08.2015
APPD:	Schumi			FINISH	Jamy	Sheet	1 from 2

Copyright by S.Tiede

# EDCON-COMPONENTS

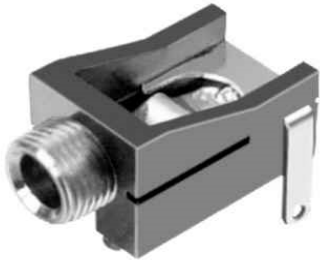

## Solder Profile

### Lead Solder

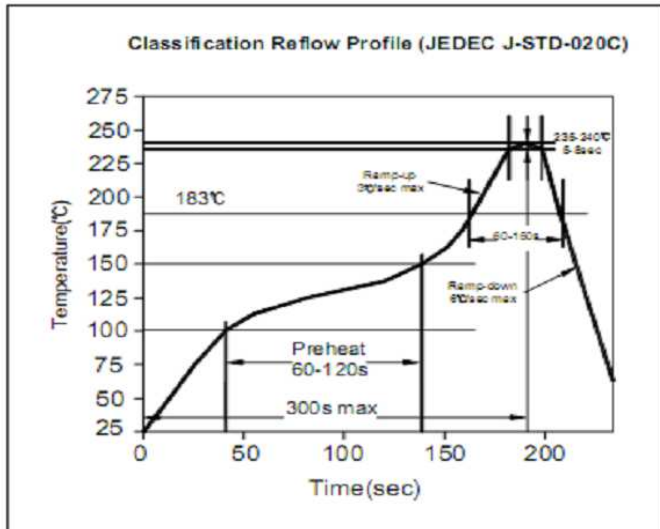

### Lead free Solder

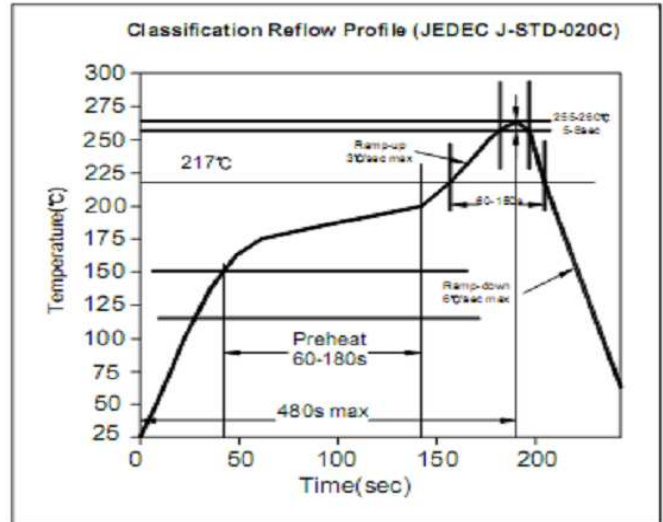

## Ordering Informations:

Item-No.	Material	ROHS	Packing			
<b>T13G007</b>	<b>A</b>	<b>R</b>	<b>BU</b>			

<b>A=</b> Copper	<b>R=</b> ROHS	<b>BU=</b> Bulk (Standard)
<b>B=</b> Steel	<b>N=</b> Non ROHS	
		<b>TY=</b> Tray Packing

3,5mm THT Audio jack	
Part No.:	<b>T13G007</b>
Customer:	

DRW:	Jason	CHKD	Wilson	MATL:	Wilson	DATE	05.08.2015
APPD:	Schumi			FINISH	Jamy	Sheet	2 from 2

Copyright by S.Tiede