

EDCON-COMPONENTS



T13A057

Technical Specifications:

Operating Temperature:	
Rated Load:	
Contact Resistance:	
Insulation Resistance:	
Withstanding Voltage:	
Actuating Force:	
Lifetime:	

. -30°C ~ + 70°C
DC 30V / 0,5A
< 0,03 Ohm
> 100M Ohm
AC 500V (50Hz) 1min.
3 ~ 20N
5000 cycles

Technical Drawing:

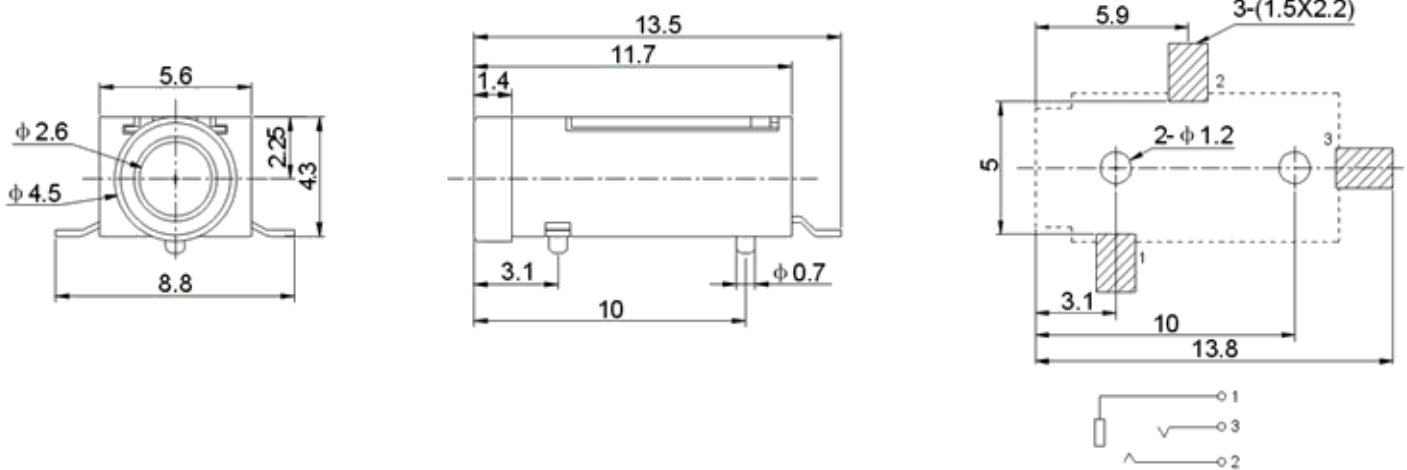

2,5mm SMT Audio jack	
Part No.:	T13A057
Customer:	

DRW:	Jason	CHKD	Wilson	MATL:	Wilson	DATE	06.05.2007
APPD:	Schumi			FINISH	Jamy	Sheet	1 from 2

Copyright by EDCON-COMPONENTS H.Schmitt 11.6.2009

EDCON-COMPONENTS



Reel Specifications

Solder Profile

Lead Solder

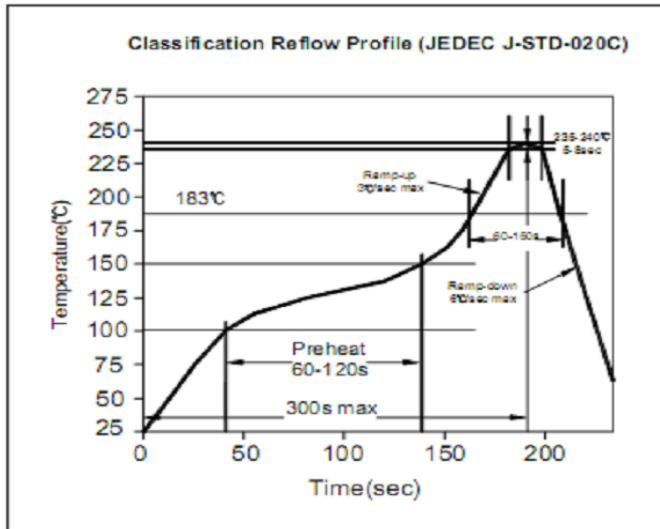

Lead free Solder



Ordering Informations:

Item-No.	Circuit	ROHS	Packing			
T13A057	A	R	BU			

A	R= ROHS	BU= Bulk (Standard)
	N= Non ROHS	
		TR= Tape/Reel
		TR= Tray Packing

2,5mm SMT Audio jack
Part No.: T13A057
Customer:

DRW:	Jason	CHKD	Wilson	MATL:	Wilson	DATE	06.05.2007
APPD:	Schumi			FINISH	Jamy	Sheet	2 from 2

Copyright by EDCON-COMPONENTS H.Schmitt 11.6.2009