

EDCON-COMPONENTS

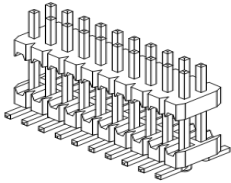

Specifications

Current Rating:	1,0 Ampere
Insulator Resistance:	1000 Megaohm min.
Dielectric Withstanding:	AC 500V
Operating Temperature:	.-40°C to +105°C
Contact Material:	Copper, Alloy
Insulator Material:	P.B.T / PA6T
Standard:	PBT
Contact Plating:	Tin, Gold or Selective Plated
Standard:	Gold Flash Overall
Selectiv Plating:	Gold flash plated on contact area / tin plated on solder area
Max. Prozessing Temp.	230°C for 60 seconds

P.C.B Layout

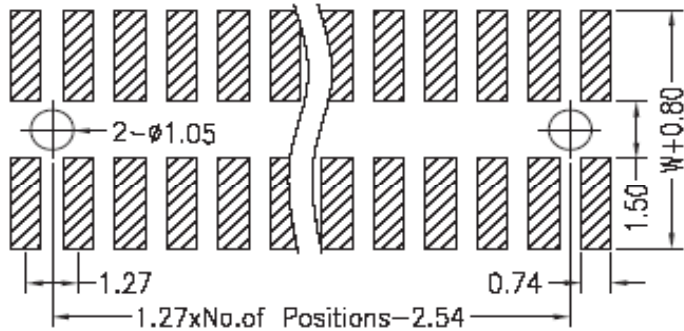

Drawing (dimensions all into mm)

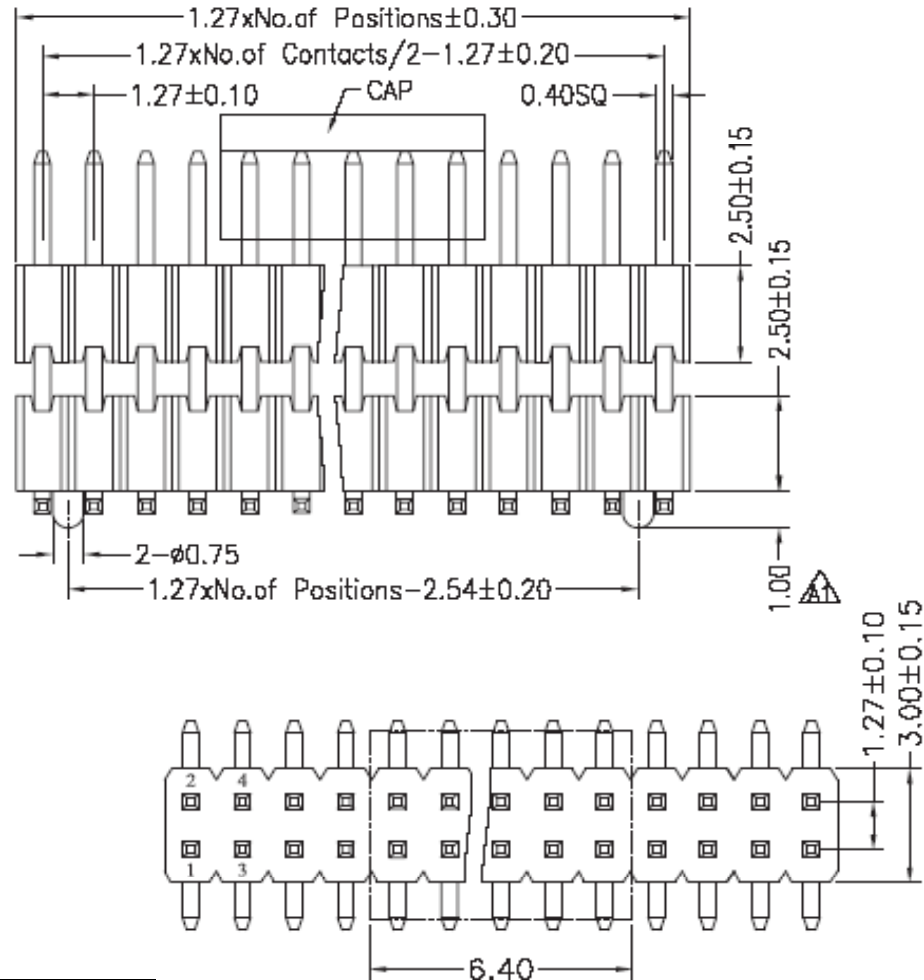

PIN Header /Dual Row / Dual Body / Pitch 1,27mm	
Part No.:	T51C1085 -
Customer:	

DRW:	Jason	CHKD	Wilson	MATL:	Wilson	TOLERANCE	Mason	DATE	21.09.2021
APPD:	Schumi			FINISH	Jamy		Sheet No.		1 from 4

EDCON-COMPONENTS

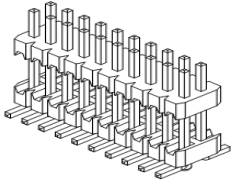

Pin Code length table free configuration

Order Code	Dimension (mm)			
	B	C	D	W
A01	3,05	6,35	0,00	5,50
A02				
A03				
A04				
A05				
A06				
A07				
A08				
A09				
A10				
A11				
A12				
A13				
A14				
A15				
A16				
A17				
A18				
A19				
A20				
A21				
A22				

Order Code	Dimension (mm)			
	B	C	D	W
A23				
A24				
A25				
A26				
A27				
A28				
A29				
A30				
A31				
A32				
A33				
A34				
A35				
A36				
A37				
A38				
A39				
A40				
A41				
A42				
A43				
A44				

Order Code	Dimension (mm)			
	B	C	D	W
A45				
A46				
A47				
A48				
A49				
A50				
A51				
A52				
A53				
A54				
A55				
A56				
A57				
A58				
A59				
A60				
A61				
A62				
A63				
A64				
A65				
A66				

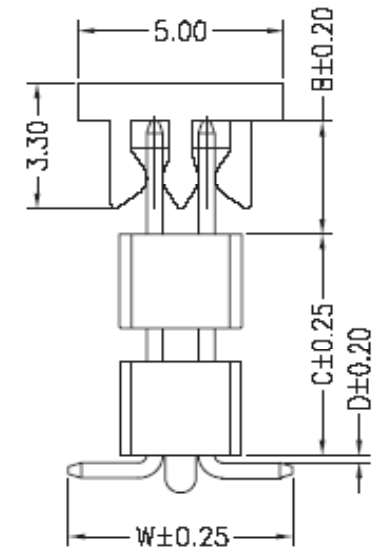

PIN Header /Dual Row / Dual Body / Pitch 1,27mm

Part No.: **T51C1085 -**

Customer:

DRW:	Jason	CHKD	Wilson	MATL:	Wilson	TOLERANCE	Mason	DATE	21.09.2021
APPD:	Schumi			FINISH	Jamy		Sheet No.		2 from 4

EDCON-COMPONENTS

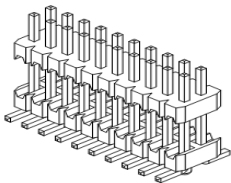

Ordering Informations

Serie	No. of Pos.	Construction	Contact Plating	Material	Special function	Pin Length Code	ROHS	Packing		
-------	-------------	--------------	-----------------	----------	------------------	-----------------	------	---------	--	--

T51C1085 -	XX	SS	G0	PA	Y	A01	R	BU		
-------------------	-----------	-----------	-----------	-----------	----------	------------	----------	-----------	--	--

XX = total pin of header	SS = Straight SMT	G0 = Gold Flash (Standard)	PA = Polyester 6T	Y = With Locating Peg	look table page 2	N =NO ROHS	BU = Bulk (Standard)
T0 = Tin plated		R =ROHS conform				TU = Tube w/o Cap	
GA = 10µ Gold Plating				TC = Tube w. pic and Place Cap			
GB = 15µ Gold Plating				TY = Tray packing w/o Cap			
GC = 20µ Gold Plating				TR = Tape/Reel w. pic and Place Cap			
S0 = Selectiv Plating Gold Flash / Tin							
TN = Tin Plated							

PIN Header /Dual Row / Dual Body / Pitch 1,27mm
Part No.: T51C1085 -
Customer:

DRW:	Jason	CHKD	Wilson	MATL:	Wilson	TOLERANCE	Mason	DATE	21.09.2021
APPD:	Schumi			FINISH	Jamy		Sheet No.		3 from 4

www.edcon-components.com

email: info@edcon-components.com

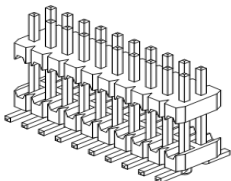

Soldering Profile for Lead Free Soldering

Classification Reflow Profile (JEDEC J-STD-020C)

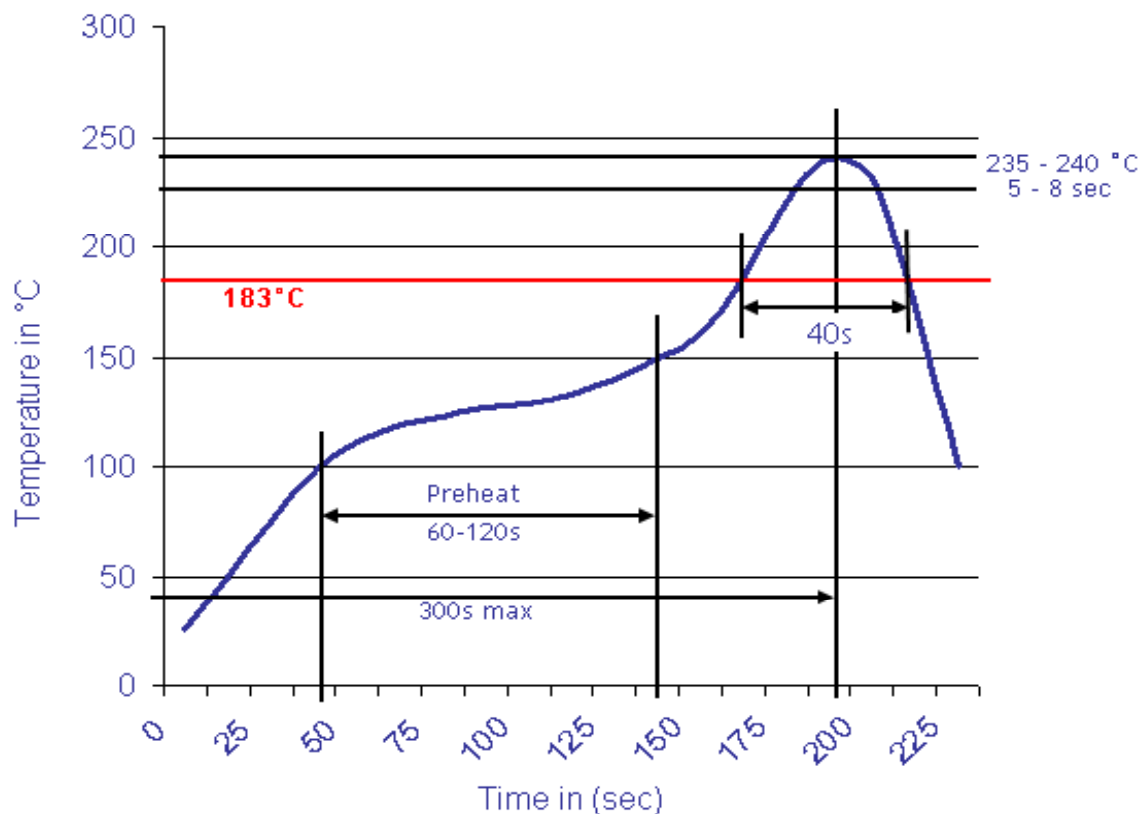

PIN Header /Dual Row / Dual Body / Pitch 1,27mm	
Part No.:	T51C1085 -
Customer:	

DRW:	Jason	CHKD	Wilson	MATL:	Wilson	TOLERANCE	Mason	DATE	21.09.2021
APPD:	Schumi			FINISH	Jamy		Sheet No.	4 from 4	