

EDCON-COMPONENTS

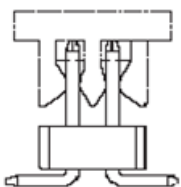

Specifications

Current Rating:	1,0 Ampere
Insulator Resistance:	1000 Megaohm min.
Dielectric Withstanding:	AC 500V
Operating Temperature:	.-40°C to +105°C
Contact Material:	Copper, Alloy
Insulator Material:	P.B.T / PA6T
Standard:	PBT
Contact Plating:	Tin, Gold or Selective Plated
Standard:	Gold Flash Overall
Selectiv Plating:	Gold flash plated on contact area / tin plated on solder area
Max. Processing Temp.	230°C for 60 seconds

P.C.B Layout

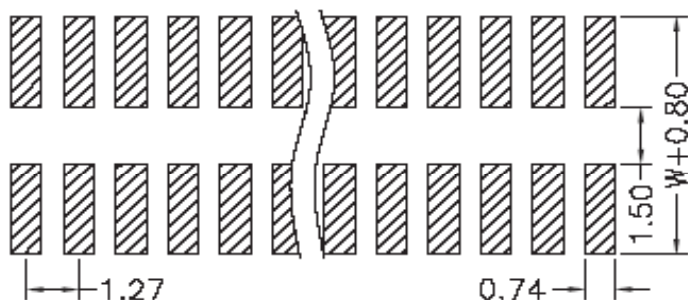

Drawing (dimensions all into mm)

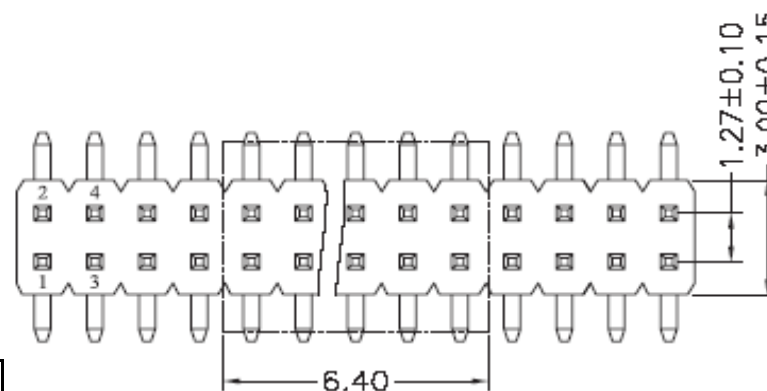
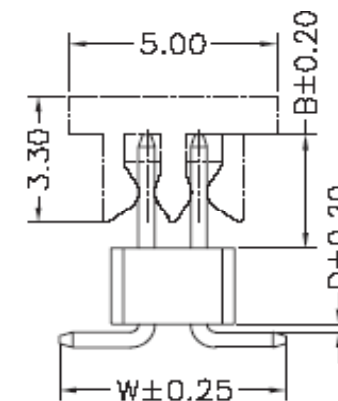
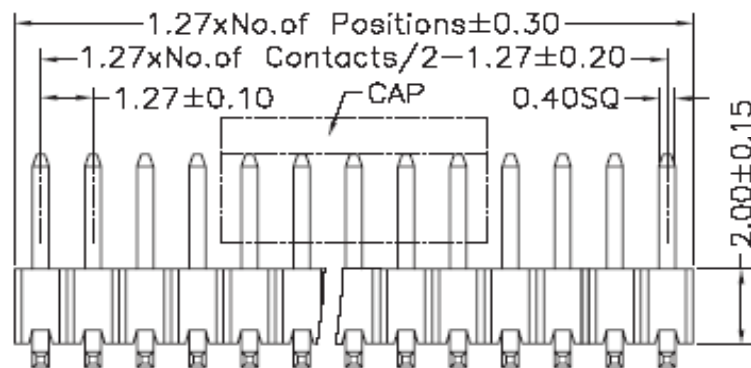

X=	X.X=	X.XX=	X.XXX=	Angle=
±0,35	±0,25	±0,20	±0,15	±5°
DRW:	Jason	CHKD	Wilson	MATL:
APPD:	Schumi		FINISH	

Wilson	TOLERANCE	Mason	DATE	28.02.2020
Jamy		Sheet No.	1 from 4	

PIN Header /Dual Row / Single Body / Pitch 1,27mm	
Part No.:	T51C1070-
Customer:	

EDCON-COMPONENTS

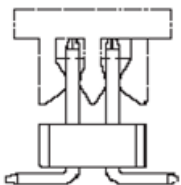

Pin Code length table free configuration

Order Code	Dimension (mm)		
	B	D	W
A01	4,00	0,00	5,40
A02	4,50	0,00	5,40
A03	5,00	0,00	5,40
A04	5,50	0,00	5,40
A05	6,00	0,00	5,40
A06			
A07			
A08			
A09			
A10			
A11			
A12			
A13			
A14			
A15			
A16			
A17			
A18			
A19			
A20			
A21			
A22			

Order Code	Dimension (mm)		
	A	B	D
A23			
A24			
A25			
A26			
A27			
A28			
A29			
A30			
A31			
A32			
A33			
A34			
A35			
A36			
A37			
A38			
A39			
A40			
A41			
A42			
A43			
A44			

Order Code	Dimension (mm)		
	A	B	D
A45			
A46			
A47			
A48			
A49			
A50			
A51			
A52			
A53			
A54			
A55			
A56			
A57			
A58			
A59			
A60			
A61			
A62			
A63			
A64			
A65			
A66			

PIN Header /Dual Row / Single Body / Pitch 1,27mm

Part No.: **T51C1070-**

Customer:

DRW:	Jason	CHKD	Wilson	MATL:	Wilson	TOLERANCE	Mason	DATE	28.02.2020
APPD:	Schumi			FINISH	Jamy		Sheet No.		2 from 4

EDCON-COMPONENTS

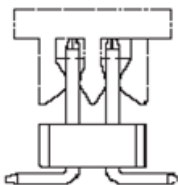

Ordering Informations

Serie	No. of Pos.	Construction	Contact Plating	Material	Special Function	Pin Length Code	ROHS	Packing		
T51C1070-	XX	SS	G0	PA	N	A01	R	BU		

XX= total pin of header	SS= Straight SMT	G0= Gold Flash (Standard)	PA= Polyester 6T	N= No function	look table page 2	N=NO ROHS conform	BU= Bulk (Standard)		
		T0= Tin plated						R=ROHS conform	TU= Tube w/o Cap
		GA= 10µ Gold Plating							TC= Tube w. pic and Place Cap
		GB= 15µ Gold Plating							TY= Tray packing w/o Cap
		GC= 20µ Gold Plating							TR= Tape/Reel w. pic and Place Cap
		S0= Selectiv Plating Gold Flash / Tin							
		TN= Tin Plated							

PIN Header /Dual Row / Single Body / Pitch 1,27mm

Part No.: **T51C1070-**

DRW:	Jason	CHKD	Wilson	MATL:	Wilson	TOLERANCE	Mason	DATE	28.02.2020
APPD:	Schumi			FINISH	Jamy		Sheet No.		3 from 4

Customer:

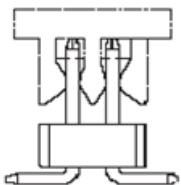

Soldering Profile for Lead Free Soldering

Classification Reflow Profile (JEDEC J-STD-020C)

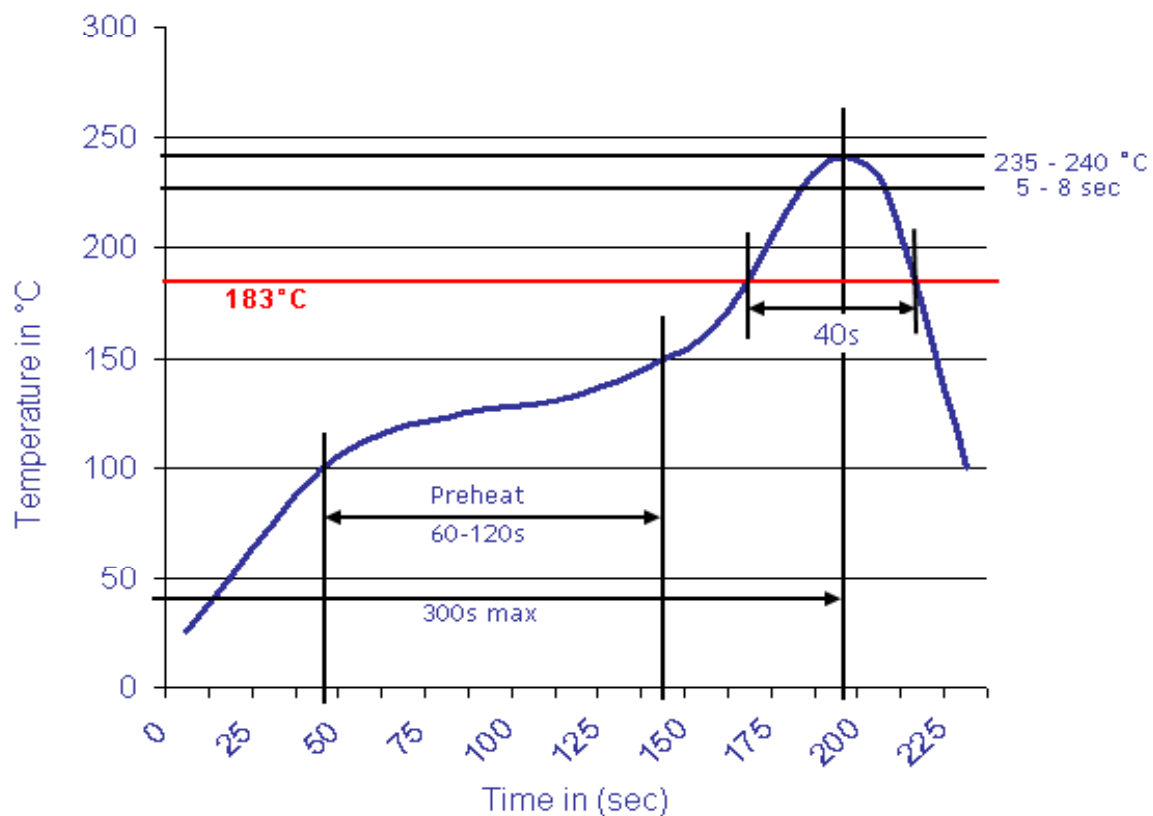

PIN Header /Dual Row / Single Body / Pitch 1,27mm	
Part No.:	T51C1070-
Customer:	

DRW:	Jason	CHKD	Wilson	MATL:	Wilson	TOLERANCE	Mason	DATE	28.02.2020
APPD:	Schumi			FINISH	Jamy		Sheet No.	4 from 4	