

EDCON-COMPONENTS

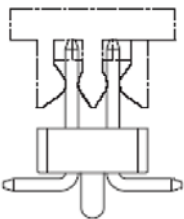

Specifications

| | |
|--------------------------|--|
| Current Rating: | 1,0 Ampere |
| Insulator Resistance: | 1000 Megaohm min. |
| Dielectric Withstanding: | AC 500V |
| Operating Temperature: | .-40°C to +105°C |
| Contact Material: | Copper, Alloy |
| Insulator Material: | P.B.T / PA6T |
| Standard: | PBT |
| Contact Plating: | Tin, Gold or Selective Plated |
| Standard: | Gold Flash Overall |
| Selectiv Plating: | Gold flash plated on contact area / tin plated on solder area |
| Max. Processing Temp. | 230°C for 60 seconds |

Drawing (dimensions all into mm)

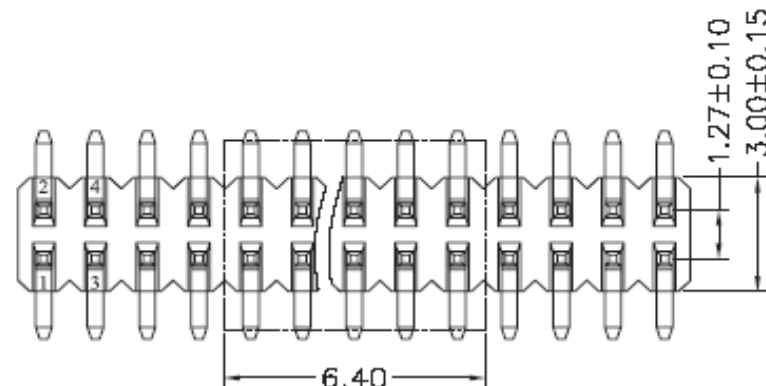

P.C.B Layout

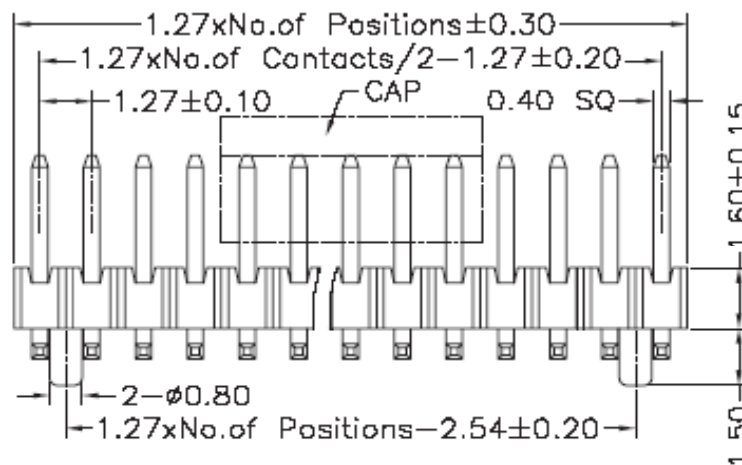
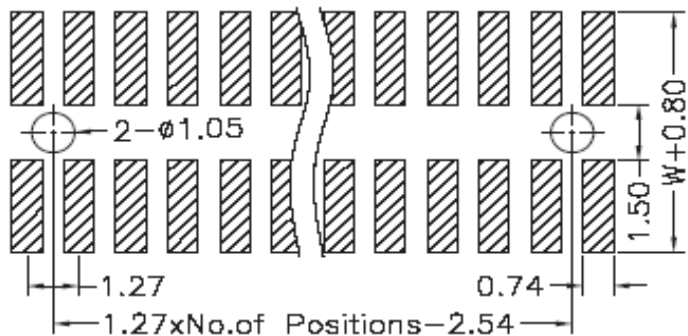

| X= | X.X= | X.XX= | X.XXX= | Angle= |
|-------|--------|-------|--------|--------|
| ±0,35 | ±0,25 | ±0,20 | ±0,15 | ±5° |
| DRW: | Jason | CHKD | Wilson | MATL: |
| APPD: | Schumi | | | FINISH |

| | | | | |
|--------|-----------|-------|-----------|------------|
| Wilson | TOLERANCE | Mason | DATE | 05.07.2019 |
| Jamy | | | Sheet No. | 1 from 4 |

| | |
|---|------------------|
| PIN Header /Dual Row / Single Body / Pitch 1,27mm | |
| Part No.: | T51C1067- |
| Customer: | |

EDCON-COMPONENTS

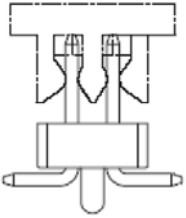

Pin Code length table free configuration

| Order Code | Dimension (mm) | | |
|------------|----------------|------|------|
| | B | D | W |
| A01 | 3,00 | 0,00 | 6,00 |
| A02 | 3,50 | 0,00 | 6,00 |
| A03 | | | |
| A04 | | | |
| A05 | | | |
| A06 | | | |
| A07 | | | |
| A08 | | | |
| A09 | | | |
| A10 | | | |
| A11 | | | |
| A12 | | | |
| A13 | | | |
| A14 | | | |
| A15 | | | |
| A16 | | | |
| A17 | | | |
| A18 | | | |
| A19 | | | |
| A20 | | | |
| A21 | | | |
| A22 | | | |

| Order Code | Dimension (mm) | | |
|------------|----------------|---|---|
| | B | D | W |
| A23 | | | |
| A24 | | | |
| A25 | | | |
| A26 | | | |
| A27 | | | |
| A28 | | | |
| A29 | | | |
| A30 | | | |
| A31 | | | |
| A32 | | | |
| A33 | | | |
| A34 | | | |
| A35 | | | |
| A36 | | | |
| A37 | | | |
| A38 | | | |
| A39 | | | |
| A40 | | | |
| A41 | | | |
| A42 | | | |
| A43 | | | |
| A44 | | | |

| Order Code | Dimension (mm) | | |
|------------|----------------|---|---|
| | B | D | W |
| A45 | | | |
| A46 | | | |
| A47 | | | |
| A48 | | | |
| A49 | | | |
| A50 | | | |
| A51 | | | |
| A52 | | | |
| A53 | | | |
| A54 | | | |
| A55 | | | |
| A56 | | | |
| A57 | | | |
| A58 | | | |
| A59 | | | |
| A60 | | | |
| A61 | | | |
| A62 | | | |
| A63 | | | |
| A64 | | | |
| A65 | | | |
| A66 | | | |

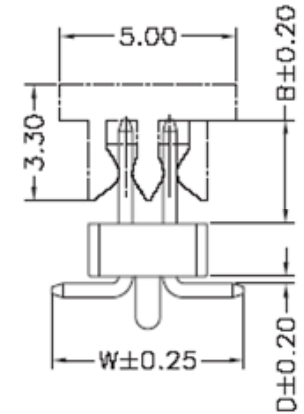

With Locating Peg

PIN Header /Dual Row / Single Body / Pitch 1,27mm

Part No.: **T51C1067-**

Customer:

| | | | | | | | | | |
|-------|--------|------|--------|--------|--------|-----------|-----------|------|------------|
| DRW: | Jason | CHKD | Wilson | MATL: | Wilson | TOLERANCE | Mason | DATE | 05.07.2019 |
| APPD: | Schumi | | | FINISH | Jamy | | Sheet No. | | 2 from 4 |

EDCON-COMPONENTS

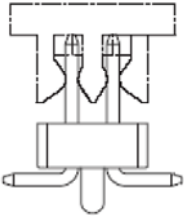

Ordering Informations

| Serie | No. of Pos. | Construction | Contact Plating | Material | Special Function | Pin Length Code | ROHS | Packing | | |
|------------------|-------------|--------------|-----------------|-----------|------------------|-----------------|----------|-----------|--|--|
| T51C1067- | XX | SS | G0 | PA | Y | A01 | R | BU | | |

| | | | | | | | |
|---|------------------------------|-----------------------------------|--------------------------|--|----------------------------------|--------------------------|-----------------------------|
| XX = total pin of header | SS = Straight SMT | G0 = Gold Flash (Standard) | PA = Polyester 6T | Y = With Locati. Peg | look table page 2 | N =NO ROHS | BU = Bulk (Standard) |
| T0 = Tin plated | GA = 10µ Gold Plating | | | | R =ROHS conform | TU = Tube w/o Cap | |
| GB = 15µ Gold Plating | GC = 20µ Gold Plating | | | TC = Tube w. pic and Place Cap | TY = Tray packing w/o Cap | | |
| S0 = Selectiv Plating Gold Flash / Tin | TN = Tin Plated | | | TR = Tape/Reel w. pic and Place Cap | | | |

| |
|---|
| PIN Header /Dual Row / Single Body / Pitch 1,27mm |
| Part No.: T51C1067- |
| Customer: |

| | | | | | | | | | |
|-------|--------|------|--------|--------|--------|-----------|-----------|------|------------|
| DRW: | Jason | CHKD | Wilson | MATL: | Wilson | TOLERANCE | Mason | DATE | 05.07.2019 |
| APPD: | Schumi | | | FINISH | Jamy | | Sheet No. | | 3 from 4 |

www.edcon-components.com

email: info@edcon-components.com

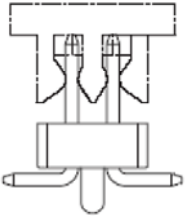

Soldering Profile for Lead Free Soldering

Classification Reflow Profile (JEDEC J-STD-020C)

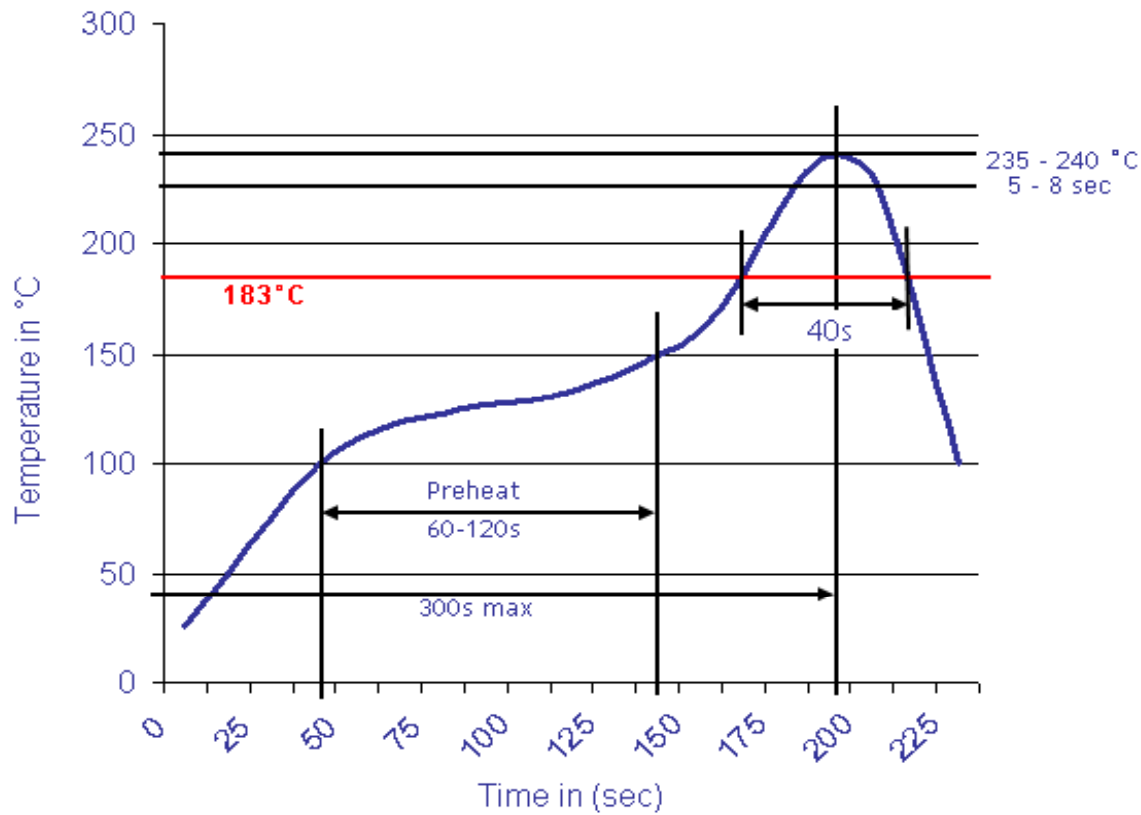

| | |
|---|------------------|
| PIN Header /Dual Row / Single Body / Pitch 1,27mm | |
| Part No.: | T51C1067- |
| Customer: | |

| | | | | | | | | | |
|-------|--------|------|--------|--------|--------|-----------|-----------|------|------------|
| DRW: | Jason | CHKD | Wilson | MATL: | Wilson | TOLERANCE | Mason | DATE | 05.07.2019 |
| APPD: | Schumi | | | FINISH | Jamy | | Sheet No. | | 4 from 4 |