

EDCON-COMPONENTS

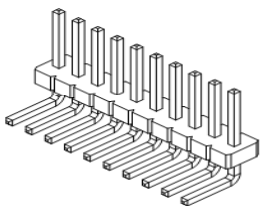

Specifications

Current Rating:	1,0 Ampere
Insulator Resistance:	1000 Megaohm min.
Dielectric Withstanding:	AC 500V
Operating Temperature:	.-40°C to +105°C
Contact Material:	Copper, Alloy
Insulator Material:	P.B.T / PA6T
Standard:	PBT
Contact Plating:	Tin, Gold or Selective Plated
Standard:	Gold Flash Overall
Selectiv Plating:	Gold flash plated on contact area / tin plated on solder area
Max. Processing Temp.	230°C for 60 seconds

P.C.B Layout

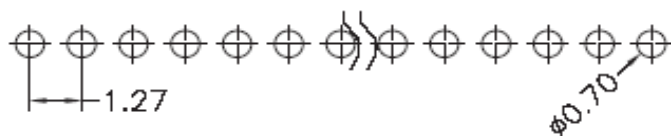

Drawing (dimensions all into mm)

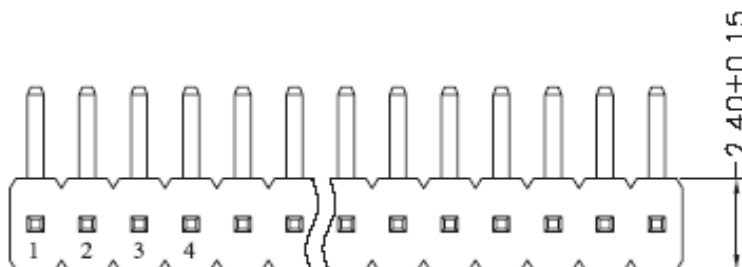
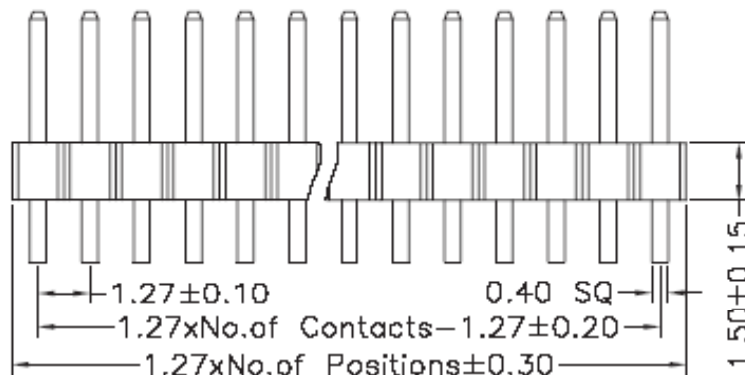

PIN Header /Single Row / Single Body / Pitch 1,27mm

Part No.: **T51C1063-**

Customer:

DRW:	Jason	CHKD	Wilson	MATL:	Wilson	TOLERANCE	Mason	DATE	07.06.2018
APPD:	Schumi			FINISH	Jamy		Sheet No.		1 from 4

EDCON-COMPONENTS

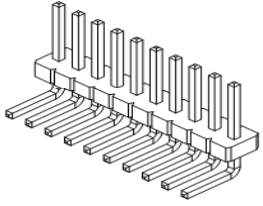

Pin Code length table free configuration

Order Code	Dimension (mm)		
	A	B	D
A01	2,30	3,00	0,50
A02			
A03			
A04			
A05			
A06			
A07			
A08			
A09			
A10			
A11			
A12			
A13			
A14			
A15			
A16			
A17			
A18			
A19			
A20			
A21			
A22			

Order Code	Dimension (mm)		
	A	B	D
A23			
A24			
A25			
A26			
A27			
A28			
A29			
A30			
A31			
A32			
A33			
A34			
A35			
A36			
A37			
A38			
A39			
A40			
A41			
A42			
A43			
A44			

Order Code	Dimension (mm)		
	A	B	D
A45			
A46			
A47			
A48			
A49			
A50			
A51			
A52			
A53			
A54			
A55			
A56			
A57			
A58			
A59			
A60			
A61			
A62			
A63			
A64			
A65			
A66			

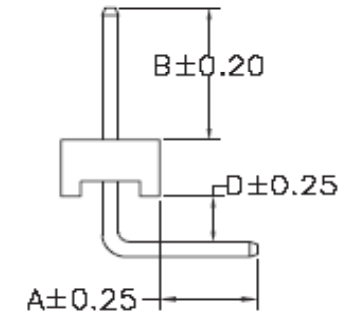

PIN Header /Single Row / Single Body / Pitch 1,27mm

Part No.: **T51C1063-**

Customer:

DRW:	Jason	CHKD	Wilson	MATL:	Wilson	TOLERANCE	Mason	DATE	07.06.2018
APPD:	Schumi			FINISH	Jamy		Sheet No.		2 from 4

EDCON-COMPONENTS

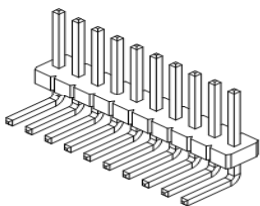

Ordering Informations

Serie	No. of Pos.	Construction	Contact Plating	Material	Special Function	Pin Length Code	ROHS	Packing		
T51C1063-	XX	RT	G0	PA	N	A01	R	BU		

XX = total pin of header	RT = Right Angle THT	G0 = Gold Flash (Standard)	PA = Polyester 6T	N = No function	look table page 2	N =NO ROHS	BU = Bulk (Standard)
T0 = Tin plated		R =ROHS conform					
GA = 10µ Gold Plating				TC = Tube w. pic and Place Cap			
GB = 15µ Gold Plating				TY = Tray packing w/o Cap			
GC = 20µ Gold Plating				TR = Tape/Reel w. pic and Place Cap			
S0 = Selectiv Plating Gold Flash / Tin							
TN = Tin Plated							

PIN Header /Single Row / Single Body / Pitch 1,27mm
Part No.: T51C1063-
Customer:

DRW:	Jason	CHKD	Wilson	MATL:	Wilson	TOLERANCE	Mason	DATE	07.06.2018
APPD:	Schumi			FINISH	Jamy		Sheet No.		3 from 4

www.edcon-components.com

email: info@edcon-components.com

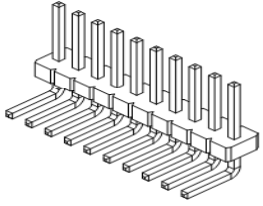

Soldering Profile for Lead Free Soldering

Classification Reflow Profile (JEDEC J-STD-020C)

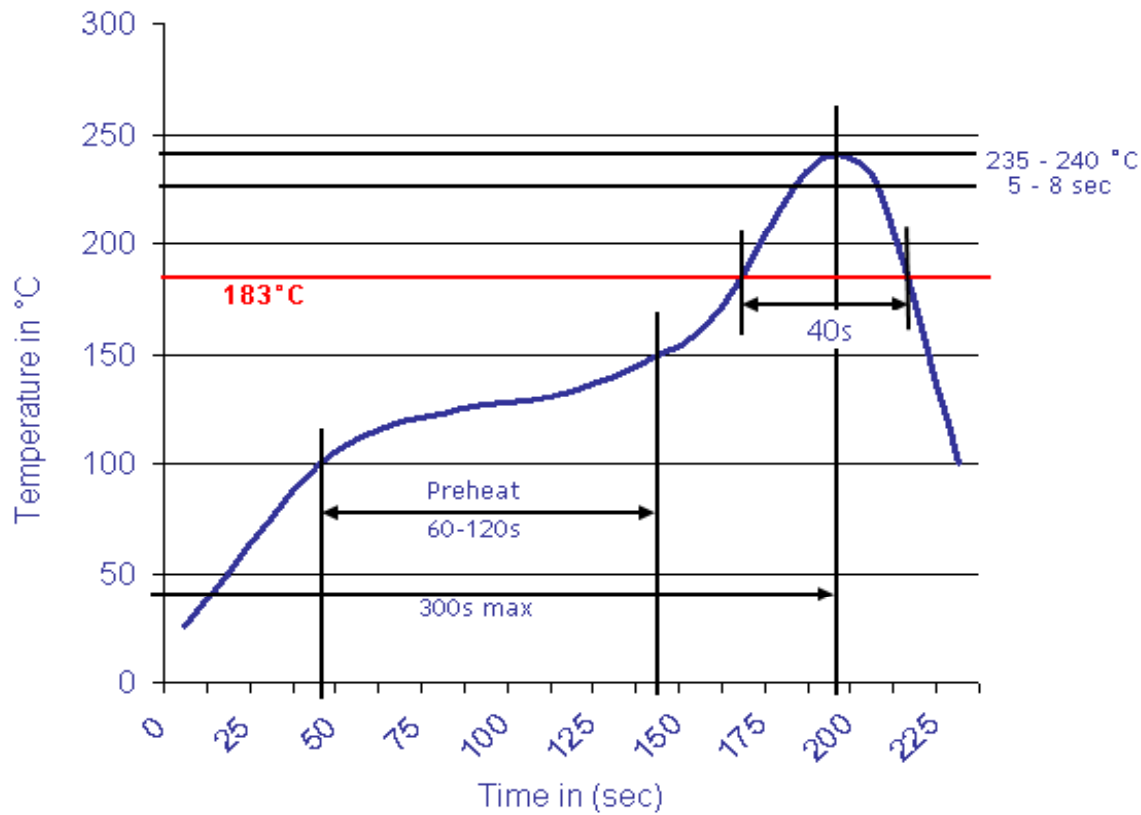

PIN Header /Single Row / Single Body / Pitch 1,27mm	
Part No.:	T51C1063-
Customer:	

DRW:	Jason	CHKD	Wilson	MATL:	Wilson	TOLERANCE	Mason	DATE	07.06.2018
APPD:	Schumi			FINISH	Jamy		Sheet No.		4 from 4