

# EDCON-COMPONENTS

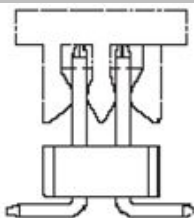

## Specifications

Current Rating:	1,0 Ampere
Insulator Resistance:	1000 Megaohm min.
Dielectric Withstanding:	AC 500V
Operating Temperature:	-.40°C to +105°C
Contact Material:	Copper, Alloy
Insulator Material:	P.B.T / PA6T
Standard:	PBT
Contact Plating:	Tin, Gold or Selective Plated
Standard:	Gold Flash Overall
Selectiv Plating:	Gold flash plated on contact area / tin plated on solder area
Max. Prozessing Temp.	230°C for 60 seconds

## P.C.B Layout

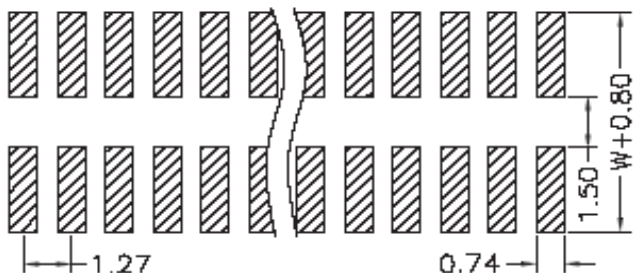

## Drawing ( dimensions all into mm)

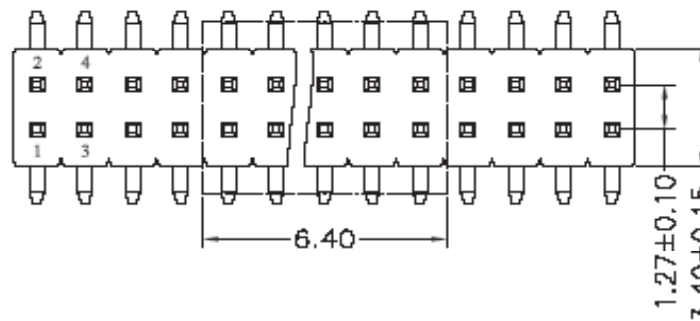
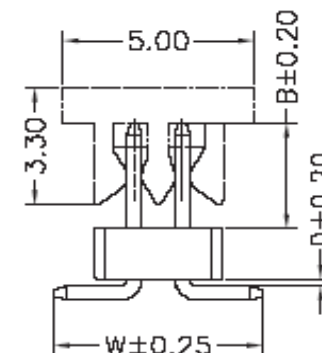
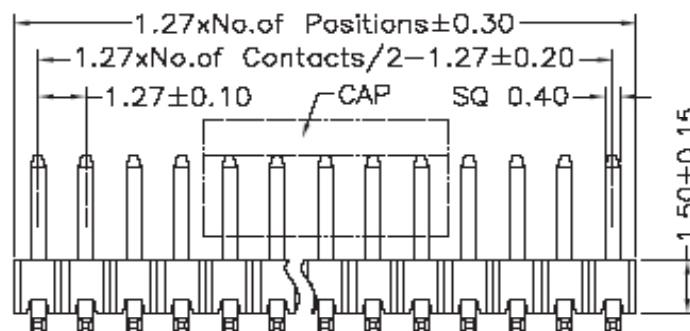

PIN Header /Dual Row / Single Body / Pitch 1,27mm

Part No.: **T51C1058-**

Customer:

DRW:	Jason	CHKD	Wilson	MATL:	Wilson	TOLERANCE	Mason	DATE	25.10.2021
APPD:	Schumi			FINISH	Jamy		Sheet No.		1 from 4

# EDCON-COMPONENTS

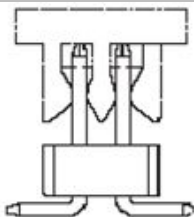

## Pin Code length table free configuration ( Your Pin length not in the table Please create by yourself )

Order Code	Dimension (mm)		
	B	D	W
A01	3,80	0,20	5,10
A02	3,40	0,30	5,50
A03	4,00	0,20	5,10
A04	4,50	0,20	5,10
A05	5,00	0,20	5,10
A06	5,50	0,20	5,10
A07	6,00	0,20	5,10
A08	6,50	0,20	5,10
A09	7,00	0,20	5,10
A10	7,50	0,20	5,10
A11	8,00	0,20	5,10
A12	8,50	0,20	5,10
A13	9,00	0,20	5,10
A14	9,50	0,20	5,10
A15	10,00	0,20	5,10
A16	10,50	0,20	5,10
A17	11,00	0,20	5,10
A18	11,50	0,20	5,10
A19	12,00	0,20	5,10
A20	12,50	0,20	5,10
A21	13,00	0,20	5,10
A22	13,50	0,20	5,10
A23	14,00	0,20	5,10
A24	14,50	0,20	5,10
A25	15,00	0,20	5,10
A26	2,00	1,00	5,10
A27	2,50	1,00	5,10
A28	3,00	1,00	5,10

Order Code	Dimension (mm)		
	B	D	W
A29	3,50	1,00	5,10
A30	4,00	1,00	5,10
A31	4,50	1,00	5,10
A32	5,00	1,00	5,10
A33	5,50	1,00	5,10
A34	6,00	1,00	5,10
A35	6,50	1,00	5,10
A36	7,00	1,00	5,10
A37	7,50	1,00	5,10
A38	8,00	1,00	5,10
A39	8,50	1,00	5,10
A40	9,00	1,00	5,10
A41	9,50	1,00	5,10
A42	10,00	1,00	5,10
A43	10,50	1,00	5,10
A44	11,00	1,00	5,10
A45	11,50	1,00	5,10
A46	12,00	1,00	5,10
A47	12,50	1,00	5,10
A48	13,00	1,00	5,10
A49	13,50	1,00	5,10
A50	14,00	1,00	5,10
A51	14,50	1,00	5,10
A52	15,00	1,00	5,10
A53	2,00	2,00	5,10
A54	2,50	2,00	5,10
A55	3,00	2,00	5,10
A56	3,50	2,00	5,10

Order Code	Dimension (mm)		
	B	D	W
A57	4,00	2,00	5,10
A58	4,50	2,00	5,10
A59	5,00	2,00	5,10
A60	5,50	2,00	5,10
A61	6,00	2,00	5,10
A62	6,50	2,00	5,10
A63	7,00	2,00	5,10
A64	7,50	2,00	5,10
A65	8,00	2,00	5,10
A66	8,50	2,00	5,10
A67	9,00	2,00	5,10
A68	9,50	2,00	5,10
A69	10,00	2,00	5,10
A70	10,50	2,00	5,10
A71	11,00	2,00	5,10
A72	11,50	2,00	5,10
A73	12,00	2,00	5,10
A74	12,50	2,00	5,10
A75	13,00	2,00	5,10
A76	13,50	2,00	5,10
A77	14,00	2,00	5,10
A78	14,50	2,00	5,10
A79	15,00	2,00	5,10
A80	3,00	3,00	5,10
A81	3,50	3,00	5,10
A82	4,00	3,00	5,10
A83	4,50	3,00	5,10
A84	5,00	3,00	5,10

Order Code	Dimension (mm)		
	B	D	W
A85	5,50	3,00	5,10
A86	6,00	3,00	5,10
A87	6,50	3,00	5,10
A88	7,00	3,00	5,10
A89	7,50	3,00	5,10
A90	8,00	3,00	5,10
A91	8,50	3,00	5,10
A92	9,00	3,00	5,10
A93	9,50	3,00	5,10
A94	10,00	3,00	5,10
A95	10,50	3,00	5,10
A96	11,00	3,00	5,10
A97	11,50	3,00	5,10
A98	12,00	3,00	5,10
A99	12,50	3,00	5,10
B00	13,00	3,00	5,10
B01	13,50	3,00	5,10
B02	14,00	3,00	5,10
B03	14,50	3,00	5,10
B04	15,00	3,00	5,10
B05	3,00	0,20	5,10
B06	???	???	???
B07			

PIN Header /Dual Row / Single Body / Pitch 1,27mm	
Part No.:	<b>T51C1058-</b>
Customer:	

DRW:	Jason	CHKD	Wilson
APPD:	Schumi		

MATL:	Wilson	TOLERANCE	Mason
FINISH	Jamy		

DATE	25.10.2021
Sheet No.	2 from 4

# EDCON-COMPONENTS

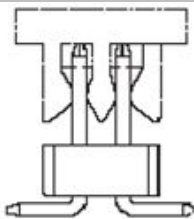

## Ordering Informations

Serie	No. of Pos.	Construction	Contact Plating	Material	Special Function	Pin Length Code	ROHS	Packing		
<b>T51C1058-</b>	<b>XX</b>	<b>SS</b>	<b>G0</b>	<b>PA</b>	<b>N</b>	<b>A01</b>	<b>R</b>	<b>BU</b>		

<b>XX=</b> total pin of header	<b>SS=</b> Straight SMT	<b>G0=</b> Gold Flash (Standard)	<b>PA=</b> Polyester 6T	<b>N=</b> No function	look table page 2	<b>N=</b> NO ROHS conform	<b>BU=</b> Bulk (Standard)
<b>T0=</b> Tin plated		<b>R=</b> ROHS conform				<b>TU=</b> Tube w/o Cap	
<b>GA=</b> 10µ Gold Plating						<b>TC=</b> Tube w. pic and Place Cap	
<b>GB=</b> 15µ Gold Plating						<b>TY=</b> Tray packing w/o Cap	
<b>GC=</b> 20µ Gold Plating						<b>TR=</b> Tape/Reel w. pic and Place Cap	
<b>S0=</b> Selectiv Plating Gold Flash / Tin							
<b>TN=</b> Tin Plated							

PIN Header /Dual Row / Single Body / Pitch 1,27mm

Part No.: **T51C1058-**

DRW:	Jason	CHKD	Wilson	MATL:	Wilson	TOLERANCE	Mason	DATE	25.10.2021
APPD:	Schumi			FINISH	Jamy		Sheet No.		3 from 4

Customer:

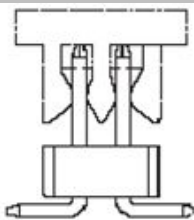

Soldering Profile for Lead Free Soldering

Classification Reflow Profile (JEDEC J-STD-020C)

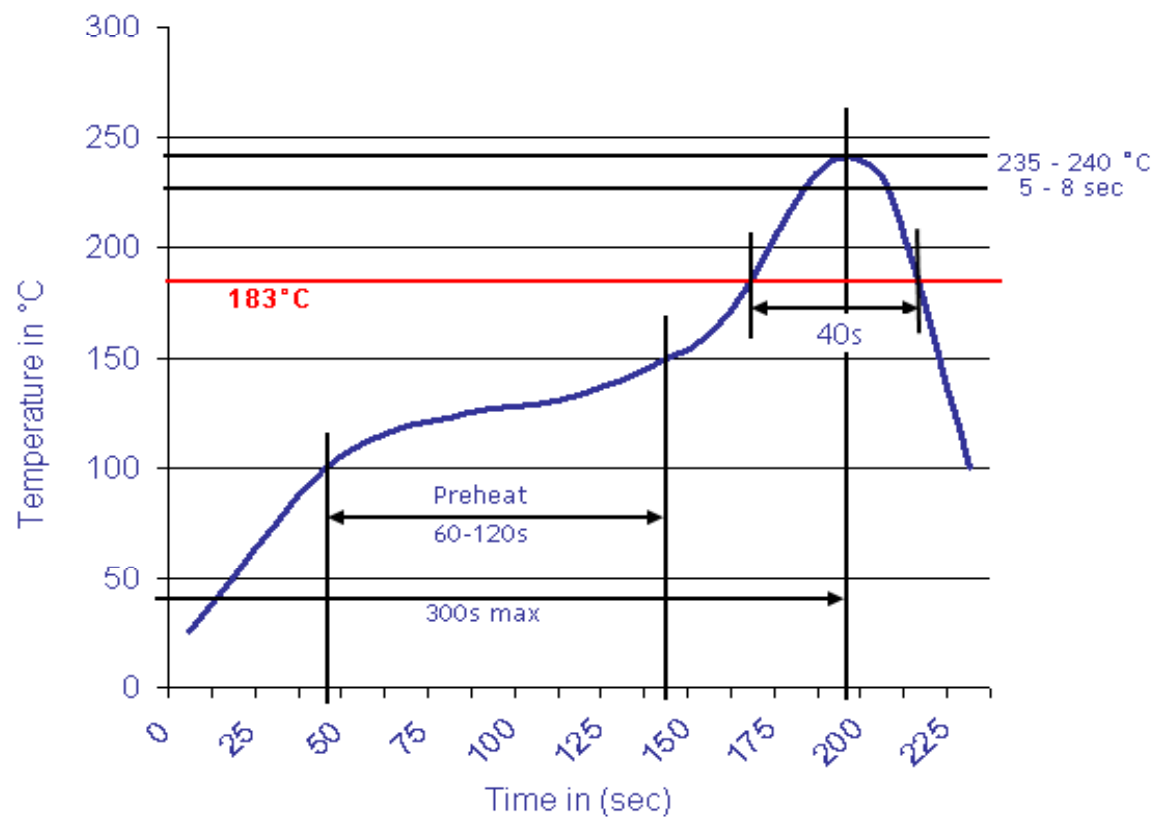

PIN Header /Dual Row / Single Body / Pitch 1,27mm	
Part No.:	<b>T51C1058-</b>
Customer:	

DRW:	Jason	CHKD	Wilson	MATL:	Wilson	TOLERANCE	Mason	DATE	25.10.2021
APPD:	Schumi			FINISH	Jamy		Sheet No.	4 from 4	