

EDCON-COMPONENTS

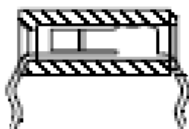

Specifications

Current Rating:	2 Ampere
Insulator Resistance:	1000 Megaohm min.
Contact Resistance:	20m Ohm max.
Dielectric Withstanding:	AC 500V
Operating Temperature:	-.40°C to +105°C
Contact Material:	Phosphor Bronze
Insulator Material:	PA6T + 30% G.F. UL94V-0
Contact Plating:	Tin, Gold or Selective Plated
Standard:	Gold Flash Overall

P.C.B Layout

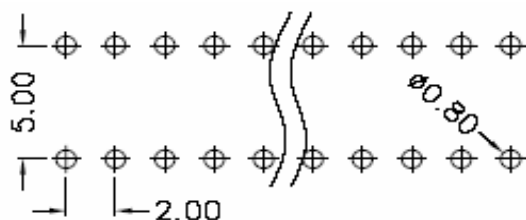

Drawing

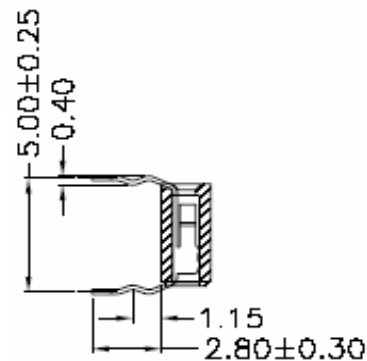
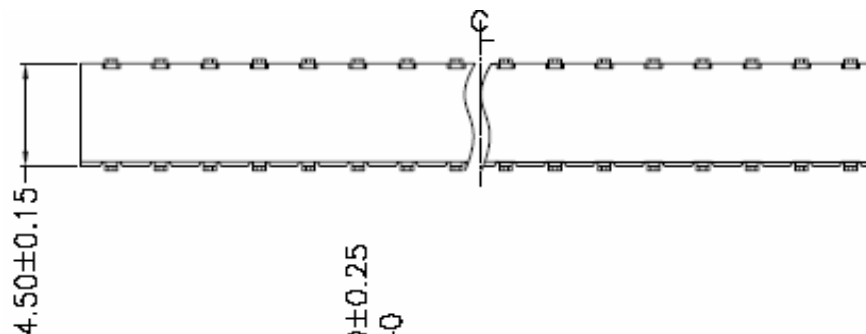
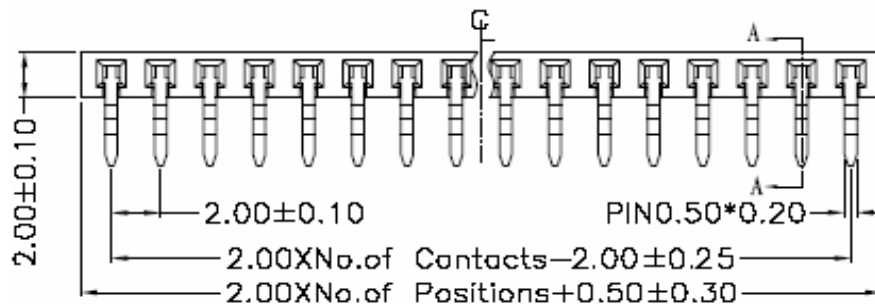

**Female Header Pitch
2,00mm**

Part No.: **T27B1036**

Customer:

DRW:	Jason	CHKD	Wilson	MATL:	Wilson	TOLERANCE	Mason	DATE	04.06.2009
APPD:	Schumi			FINISH	Jamy		Sheet No.	1 from 4	

EDCON-COMPONENTS

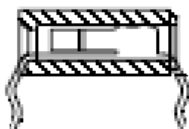

Pin Code length table free configuration

Order Code	Dimension (mm)			
	W			
A01	2,80			
A02				
A03				
A04				
A05				
A06				
A07				
A08				
A09				
A10				
A11				
A12				
A13				
A14				
A15				
A16				
A17				
A18				
A19				
A20				
A21				
A22				

Order Code	Dimension (mm)			
A23				
A24				
A25				
A26				
A27				
A28				
A29				
A30				
A31				
A32				
A33				
A34				
A35				
A36				
A37				
A38				
A39				
A40				
A41				
A42				
A43				
A44				

Order Code	Dimension (mm)			
A45				
A46				
A47				
A48				
A49				
A50				
A51				
A52				
A53				
A54				
A55				
A56				
A57				
A58				
A59				
A60				
A61				
A62				
A63				
A64				
A65				
A66				

**Female Header Pitch
2,00mm**

Part No.: **T27B1036**

DRW:	Jason	CHKD	Wilson	MATL:	Wilson	TOLERANCE	Mason	DATE	04.06.2009
APPD:	Schumi			FINISH	Jamy		Sheet No.		2 from 4

Customer:

EDCON-COMPONENTS

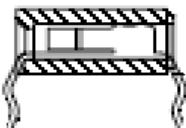

Ordering Informations

Serie	No. of Pos.	Construction	Contact Plating	Material	Special Function	Pin Length Code	ROHS	Packing		
T27B1036	XX	RT	G0	PA	N	A01	R	BU		

02 ~ 40Pos.	RT= Right Angle THT	G0= Gold Flash (Standard)	PA= PA-46T	N= No Function	look Table No. 1	N= NO ROHS conform R= ROHS conform	BU= Bulk (Standard)
		T0= Tin plated					TU= Tube w/o Cap
		GA= 10µ Gold Plating					TC= Tube w. pic and Place Cap
		GB= 15µ Gold Plating					TY= Tray packing w/o Cap
		GC= 20µ Gold Plating					TR= Tape/Reel w. pic and Place Cap
		S0= Selectiv Plating Gold Flash / Tin					
		SA= Selectiv Plating Gold 3µ / Tin					SD= Selectiv Plating Gold 15µ / Tin
		SB= Selectiv Plating Gold 5µ / Tin					SE= Selectiv Plating Gold 20µ / Tin
SC= Selectiv Plating Gold 10µ / Tin	SF= Selectiv Plating Gold 30µ / Tin						

Female Header Pitch 2,00mm	
Part No.:	T27B1036
Customer:	

DRW:	Jason	CHKD	Wilson	MATL:	Wilson	TOLERANCE	Mason	DATE	04.06.2009
APPD:	Schumi			FINISH	Jamy		Sheet No.		3 from 4

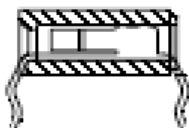

Soldering Profile for Lead Free Soldering (PA6T)

Classification Reflow Profile (JEDEC J-STD-020C)

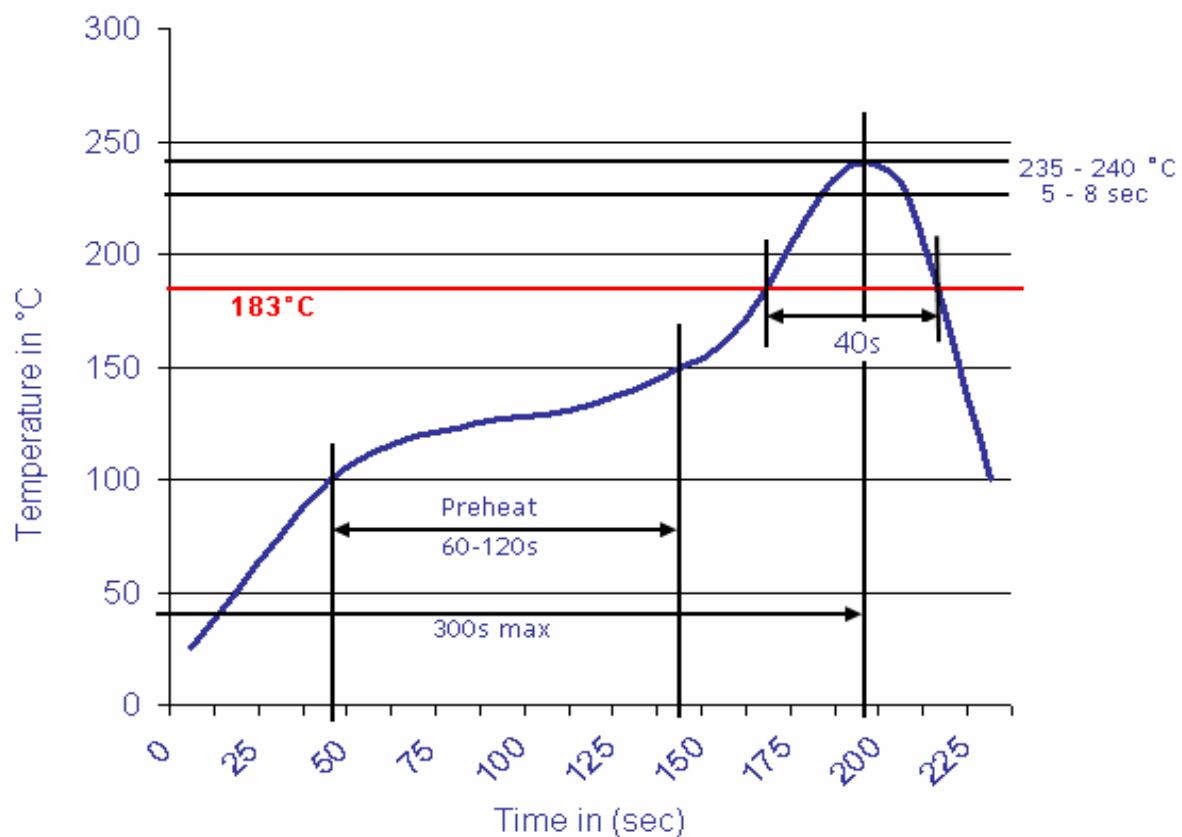

Female Header Pitch 2,00mm	
Part No.:	T27B1036
Customer:	

DRW:	Jason	CHKD	Wilson	MATL:	Wilson	TOLERANCE	Mason	DATE	04.06.2009
APPD:	Schumi			FINISH	Jamy		Sheet No.	4 from 4	